



# Operation Manual

---

---

## T20JE/T22JE/T26JE/T28JE

### Telescopic Boom

### Mobile Elevating Work Platform



Before operation and maintenance, the drivers and service personnel shall always read and thoroughly understand all information in this manual. Failure to do so may result in, fatal accidents or personal injury.

This manual must be kept with this machine at all times.

**T20JE/T22JE/T26JE/T28JE**  
**Telescopic Boom Mobile Elevating Work Platform**  
**Operation Manual**

880\*1230 mm sixteen format 8 printed sheet

Seventh edition and printed for the first time in March 2023

---

**Lingong Heavy Machinery Co., Ltd.**

Add: F12, Building 3 LushangGuoao Plaza, 9777 Jingshi Road, Lixia District, Jinan, Shandong, 250000, China

Tel: 86-0531-67605017

Technical service: 86-0531-67605017

Web: [www.LGMG.com.cn](http://www.LGMG.com.cn)

Sales of accessories: 86-0531-67605016

---

# Contents

Contents.....	I
Foreword.....	III
Safety Notices.....	IV
Chapter 1 Safety.....	1
1.1 Hazards.....	3
1.2 Before Operation, Please Ensure that:.....	3
1.3 Classification of Hazards.....	3
1.4 Intended Use.....	3
1.5 Safety Sign Maintenance.....	3
1.6 Electric Shock Hazard.....	4
1.7 Danger of Tip-over.....	4
1.8 General Safety.....	6
1.9 Operating Hazards on Slopes.....	6
1.10 Falling Hazard.....	7
1.11 Collision Hazard.....	7
1.12 Components Damage Hazard.....	7
1.13 Explosion and Fire Hazards.....	7
1.14 Machine Damage Hazard.....	7
1.15 Danger of Bodily Injury.....	8
1.16 Battery Safety.....	8
1.17 Locked after Each Use.....	9
1.18 Personal Fall Protection.....	9
1.19 Ground Information.....	9
Chapter 2 Legend.....	11
Chapter 3 Label.....	15
Chapter 4 Overall Machine Parameters.....	23
Chapter 5 Control Box.....	41
5.1 GCU.....	43
5.2 PCU.....	45
Chapter 6 Pre-operation Inspection.....	49
6.1 Before Performing This Operation, Ensure that.....	51

6.2 Basic Principles .....	51
6.3 Pre-operation Inspection.....	51
Chapter 7 Workplace Inspection .....	53
7.1 Basic Principles .....	55
7.2 Workplace Inspection.....	55
Chapter 8 Functional Testing.....	57
8.1 Basic Principles .....	59
8.2 At GCU .....	59
8.3 On the Platform .....	59
Chapter 9 Operating Instructions.....	63
9.1 Basic Principles .....	65
9.2 Machine Operation .....	65
9.3 Emergency Shutdown.....	65
9.4 Emergency Power .....	65
9.5 Operation on the Ground .....	65
9.6 Operation on the Platform.....	65
9.7 Platform Overload.....	67
9.8 Machine Not Level.....	67
9.9 Instructions for Red Guard Protective System .....	68
9.10 Battery Charging.....	68
9.11 Description of the panel bracket.....	71
9.12 System Failure.....	73
9.13 After Each Use.....	76
Chapter 10 Transportation Instructions.....	77
10.1 Observing the Regulations.....	79
10.2 Brake Release .....	79
10.3 Ensuring Transportation Safety.....	79
10.4 Guidance for Lifting.....	80

## Foreword

You are welcome to purchase and use the lifting platform produced by LINGONG HEAVY MACHINERY CO., LTD. This machine is designed according to BS EN280-1:2022. This manual introduces the use safety, operation instructions and maintenance of the lifting platform.

Getting the best out of your machine is a goal that we pursue together with you, depending on how familiar you are with it and how carefully and thoroughly it is maintained.

We sincerely hope that you can read through this manual before starting, performing operation and maintenance for the first time, and be handy about the operation and maintenance introduced therein.

The illustrations and instructions in this manual are correct at the time of publication, but the structure and performance of our products are constantly improved and perfected. The design, operation and maintenance instructions are subject to change without notice. Please understand.

For the latest information about the machine and questions about this manual, please consult our company.

This manual is suitable for telescopic boom lifting platform. Under no circumstances shall any act or operation prohibited in this manual be performed. Users shall strictly follow the maintenance interval specified in this manual and other materials delivered with the product.

This manual should always be kept in the specified location for easy reference. This manual is part of the machine and should be handed over with it when ownership or use of the machine is transferred. If the manual is missing, damaged or illegible, please replace it in time!

The copyright of this manual belongs to LINGONG HEAVY MACHINERY CO., LTD., and cannot be copied or reproduced without the written permission of our company.



**Operators and maintenance personnel must read, understand and abide by the safety regulations and operating instructions specified in this manual before operating and maintaining this machine, otherwise, it may lead to casualties!**

**Only specially trained and qualified personnel can operate, maintain and repair the machine.**

**Improper operation, maintenance and repair are dangerous and may result in injury or death.**

**Users shall be familiar with the rated load, and overloading is strictly prohibited. The users shall be responsible for all the consequences caused by overloading or unauthorized modification.**

**The operating procedures and precautions provided in this manual are only applicable to the specified purposes of this machine. If it is used for operations other than those specified but not prohibited, make sure that there is no potential safety hazard.**

# Safety Notices

Operators should understand and follow the current national and local safety regulations, and use the safety instructions in this manual if there are no corresponding regulations.

Most accidents are caused by the user's violation of the regulations on machine operation and maintenance. To avoid accidents, please read, understand and comply with all requirements, precautions and warnings in this manual and machine labels before operation and maintenance.

This manual is not a training manual for lifting platform operators! All operating instructions are for professionals who have received lifting platform relevant training.

Since it is impossible to foresee all possible hazards and accidents, the safety instructions in this manual cannot include all safety precautions, and other existing safety risks must be taken into account in the actual operation. If a procedure or operation not recommended in this manual is used, the operator must carry out a risk assessment and must ensure the safety of himself and others and that no damage is done to the machine. If the safety of some operations is not certain, please contact our company or dealer.

If the content of this manual is inconsistent with the standards or laws and regulations issued by the local government or authorities, please enforce the stricter policy.

The operation and maintenance precautions given in this manual are only applicable to the specified use of this machine. If the machine is used outside the specified purpose, our company will not assume any responsibility, and all responsibilities shall be borne by the user and the operator.

In any instance, the prohibited operations in the manual can not be carried out.

The following markers are used to identify safety information in this manual:



**DANGER** - Indicating any dangers that, if not avoided, will cause serious injury or even death, and also serious machine damage.



**WARNING** - Indicating any dangers that, if not avoided, may cause injury, serious injury or even death, and also serious machine damage.



**CAUTION** - Indicating dangers that, if not avoided, may cause minor or moderate injury, and also machine damage or shortened machine service life.

# Chapter 1 Safety





## 1.1 Hazards

 **WARNING:** Failure to follow the instructions and safety rules in this manual may result in serious injury or death. Alcoholics, drug addicts, and those taking reaction inhibiting drugs are strictly prohibited from approaching and operating the machine.

## 1.2 Before Operation, Please Ensure that:

- 1) Equipped with PPE, such as helmet, seat belt, safety shoes, goggles, protective gloves, etc., and in good physical condition.
- 2) You have understood and implemented the safety rules for machine operations in this Operation Manual.
- 3) Know and understand the rules for safe operation of the machine before proceeding to the next step.
- 4) Always perform the check before the operation.
- 5) Always perform a functional test before use.
- 6) Check the workplace.
- 7) Use the machine only for specified purposes.
- 8) All applicable laws and regulations shall be read, understood and complied with.
- 9) Been trained to operate the machine safely.

## 1.3 Classification of Hazards

Symbols, color codes and symbolic words used in LGMG products have the following meanings:

- 1) Safety warning sign - used to warn of potential personal injuries. Observe all safety tips at the back of the sign to avoid possible personal injury or death.



- 2) Red indicates a dangerous situation. If it is not avoided, it will lead to death or serious injury.



- 3) Orange indicates a dangerous situation. If not avoided, it may cause death or serious injury.



- 4) Yellow indicates a dangerous situation. If not avoided, it may cause minor or moderate personal injury.



- 5) Blue indicates a dangerous situation. If not avoided, it may result in property loss.

## 1.4 Intended Use

The use of this machine is limited to lifting personnel and their tools and materials to workplaces at heights and it can be used indoors and outdoors.

 **WARNING:** It is strictly forbidden to modify the machine without permission, carry goods, and hang or lift articles.

## 1.5 Safety Sign Maintenance

- 1) Replenish missing and replace damaged safety sign.
- 2) Clean the safety sign with neutral cleaning agent or clean water.
- 3) Solvent-based cleaners may damage the

safety sign. Do not use solvent-based cleaners to clean the safety sign.

## 1.6 Electric Shock Hazard

**! WARNING: This machine is not insulated and does not provide shock protection when in contact with or near wires, power supplies or electrical equipment.**



Please maintain a sufficient safe distance from the wires, power supplies and power equipment in accordance with applicable laws and regulations and the following table.

Voltage	Required safety distance
0-50 KV	3.05m
50 KV-200 KV	4.60m
200 KV-350 KV	6.10m
350 KV-500 KV	7.62m
500 KV-750 KV	10.67m
750 KV-1,000 KV	13.72m

Table 1-1 Safe distance between the equipment and power line

**! CAUTION: The influence of strong wind or gust on the movement of the platform, the swing and relaxation of wires should be considered.**

If the machine comes into contact with live wires, immediately keep away from the machine.

Before cutting off the power supply of wires, it is forbidden for personnel to come in contact with or operate the machine.

Do not operate and use the machine in case of

lightning or storm.

Do not use the machine as a ground wire during welding.

## 1.7 Danger of Tip-over

- 1) The total weight of the personnel, equipment and materials on the platform shall not exceed the maximum bearing capacity of the platform.

Item	T20JE/T22JE T26JE/T28JE
	Maximum Load Capacity of the Platform
Maximum occupants	2
	3 (Restricted)

Table 1-2 Maximum load capacity of the platform



- 2) Only when the machine is on solid, flat ground can the boom be raised and extended.



- 3) If the platform is overloaded, the buzzer will alarm. Please reduce the platform load first.
- 4) When the platform is raised, the speed of the machine shall not exceed 0.8 km/h.
- 5) The tilt sensor cannot be considered as a level indicator. The buzzer on the rotary table will only sound when the machine is heavily tilted.

- 6) If the buzzer sounds when the platform is lifted, be very careful, as the Machine not level indicator lamp will come on and the drive function will not be available in both directions. First determine the state of the boom on the slope, as shown below. Then lower the boom as follows before moving the machine to a solid, level ground. Do not rotate the boom when lowering.

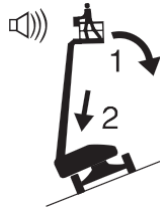

If the buzzer sounds when the platform goes uphill

- ① Lower the boom
- ② Retract the boom

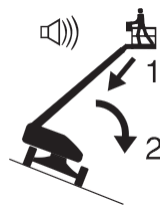

If the buzzer sounds when the platform goes downhill

- ① Retract the boom
- ② Lower the boom



- 7) Do not raise the boom when the wind speed may exceed 12.5 m/s. If the wind speed exceeds 12.5 m/s after the boom is raised, lower the boom and do not continue to operate the machine.
- 8) Do not operate the machine in strong wind or gust. Do not increase the surface area of the platform or load. Increasing the area exposed to the wind will reduce the stability of the machine.
- 9) When the platform is tripped, stuck, or other nearby objects hinder its normal movement,

do not use the PCU to operate the machine. If you intend to operate the machine by using the GCU, you must operate it after all personnel have left the platform.



- 10) Be very careful and reduce the speed when the machine is driven on a surface with crushed stone, unstable or slippery or near a hole or on a steep slope in the stowed state.
- 11) When the boom is raised, the machine cannot be driven on uneven terrain, unstable surfaces or other dangerous conditions, or near these areas.



- 12) Do not push or pull any object outside the platform. The maximum allowable manual force of the machine is 400N.
- 13) The machine cannot be used as a crane.



- 14) Do not place, tie down or hang loads on any part of the machine.
- 15) Do not push machine or other objects with boom.
- 16) When the vehicle goes downhill, please operate in the low speed range, and it is forbidden to go downhill at high speed.
- 17) When the vehicle is driving on a slope, it is forbidden to use the emergency stop switch.

## 1.8 General Safety

- 1) The machine cannot be operated with the hood open.
- 2) Do not allow boom to approach or touch any objects.
- 3) All sensors such as those for long angle, inclination, weighing, rope breaking detection shall not be changed or disabled.
- 4) Boom or platforms must not be bound to adjacent objects.



- 5) Do not modify this machine without the prior written permission of the manufacturer. Installing additional devices for placing tools or materials on platform, pedals or guardrails will increase the weight and surface area of the platform.
- 6) Ladders or scaffolding shall not be placed in the platform or against any part of the machine.
- 7) Only tools and materials that are evenly distributed and can be safely moved by people on the platform can be transported.
- 8) Do not use machines on moving or shaky surfaces or on vehicles.
- 9) Do not place hands and arms close to areas with danger of cutting or smashing.
- 10) Do not change or damage any component that may affect the safety and stability of the machines.
- 11) Key part affecting the stability of the machine shall not be replaced with part of different Spec.
- 12) Ensure that all tires are in good condition and the nuts are properly tightened. Do not replace the original tire with a tire of different Spec.
- 13) The ambient temperature for the use of the machine shall be  $-20\text{ }^{\circ}\text{C} \sim 40\text{ }^{\circ}\text{C}$ , and the relative humidity should not be greater than 90% (at  $20\text{ }^{\circ}\text{C}$ ).

- 14) Ensure that this manual is kept in the file box in the platform.
- 15) Total vibration value to which the hand/arm system is subjected does not exceed  $2.5\text{ m/s}^2$ . Highest root mean square value of weighted acceleration to which the whole body is subjected does not exceed  $0.5\text{ m/s}^2$ .

## 1.9 Operating Hazards on Slopes

Do not drive the machine on a slope that exceeds the maximum uphill, downhill or side slope rated value of the machine. Slope rating is only applicable to machines in stowed state.

The maximum slope rating when the boom is stowed is as follows





Item	Parameters
	T20JE/T22JE/T26JE/T28JE
 Platform in downhill direction	45%(24°)
 Platform in uphill direction	30%(17°)
 Platform side slope	25%(14°)

Table 1-3 Maximum slope rating for when the boom is retracted

 **CAUTION: Slope rating is limited by ground condition and traction. Refer to Driving on Slopes in the Operating Instructions section of this manual.**

 **Danger of sliding slope:**

**When the machine is working on a slope exceeding the maximum and rated gradation, a slip may occur. A slip may lead to death or serious**

**injury.**

## 1.10 Falling Hazard

- 1) During the operation, the staff on the platform must wear PPE, such as helmet, safety belt and safety shoes according to the site needs, and use, inspect, and regularly replace them according to the manufacturer's instructions.



**WARNING: Seat belt hooks must be fixed to approved rope fixing points, and only one hook can be tied to each rope fixing point.**



- 2) Do not sit, stand or climb on the protective fence of the platform. Stand stably on the platform floor at all times.
- 3) When the platform is lifted, it is not allowed to climb down from the boom.
- 4) Keep the platform floor free of debris, sundries, grease and other slippery substances.
- 5) Please close the entrance door before operation.
- 6) Do not enter or leave the platform unless the machine is tucked up.

## 1.11 Collision Hazard

- 1) Exercise good judgment and planning when operating machines on the ground. Keep a safe distance between the operator, the machine and the object.
- 2) When starting or operating the machine, pay attention to the sight range and the existence of blind spots.



- 3) When rotating the rotary table, pay

attention to the position of the boom and rotary table swing tail.

- 4) Check the work area to avoid obstacles or other possible dangers overhead.
- 5) Beware of the squeezing danger when grasping the platform fence.
- 6) When there are no people and obstacles in the lower area, the boom can be lowered.
- 7) Limit travel speed according to ground conditions, congestion level, slope, personnel position and any other factors that may cause collision.
- 8) The machine cannot be operated on the route of any crane or mobile overhead machinery unless the crane controller is locked or precautions have been taken to prevent any potential collision.
- 9) Do not operate the machine dangerously or playfully.
- 10) Users must abide by the user rules, workplace rules and government rules for personal protection equipment.
- 11) Attention shall be paid to the direction of driving and steering function.

## 1.12 Components Damage Hazard

- 1) Charge the battery with a LGMG approved battery charger.
- 2) Do not use the machine as a ground wire during welding.
- 3) Do not use the machine where magnetic fields may exist.

## 1.13 Explosion and Fire Hazards

- 1) The battery can only be recharged in places that are open, well-ventilated and away from fire sources such as sparks and burning cigarettes.
- 2) The machine shall not be used and the battery shall not be charged in places where flammable and explosive gases or dust may exist.

## 1.14 Machine Damage Hazard

- 1) A machine that have been damaged or

faulty shall not be used.

- 2) The machine shall not be used as a ground wire during welding, and the battery positive and negative electrodes must be disconnected during welding.
- 3) The machine shall not be used where strong magnetic fields, strong ionization and radioactive radiation may exist.
- 4) Before every shift, the pre-operation inspection of the machine shall be strictly carried out and all functions shall be tested. The damaged or faulty machine shall be marked immediately and the operation shall be stopped.
- 5) Ensure that all inspections and maintenance have been carried out as specified in this manual.
- 6) Ensure that all labels are located properly and easily identified.



- 1) Lead-acid battery contains acid. Wear protective clothing and protective glasses when maintaining battery.
- 2) Avoid spillage or contact with acidic substances in the battery. Use soda and water to neutralize spilled battery acid.
- 3) Wear insulating shoes and insulating gloves when maintaining the battery pack.
- 4) The battery pack must remain positioned vertically.
- 5) Do not expose the battery or charger to water or rain.
- 6) When cleaning the vehicle, it is forbidden to directly flush and wash the battery, charger and other electrical components.
- 7) Disconnect the main power switch when transporting, repairing or parking the vehicle for a long time.

## 1.15 Danger of Bodily Injury



- 1) Please do not operate the machine when the hydraulic oil leaks. Hydraulic oil leakage may penetrate or burn the skin, and the goggles and protective gloves must be worn when checking the hydraulic oil leakage.
- 2) Incorrect contact with any components under the hood will result in serious injury, and only trained maintenance personnel can open the hood for overhaul. The hood can be opened by the operator for inspection only when the pre-run inspection is carried out. All hoods must remain closed during operation.
- 3) It is forbidden to carry out maintenance work when the equipment is electrically charged or the hydraulic system is under pressure.

## 1.16 Battery Safety

### Danger of burns

### Explosion hazard



- 1) During charging or maintenance, sparks, flames and ignited cigarettes are prohibited from approaching the battery.
- 2) The hood must remain open throughout the charging process.
- 3) Do not touch battery terminals or cable clamps with tools that may cause sparks.

### Danger of damage to components

- 1) The battery pack must be charged together.



- 2) Use a charger approved by the LGMG to charge the battery.

### Electric Shock/Burn Hazard

- 1) When charging with the charger, only connect the battery charger to a grounded AC three-wire power outlet.
- 2) Check cables, wires and wiring daily for damage. Replace damaged items before operation.
- 3) Avoid electric shock due to contact with battery terminals. Remove all rings, watches and other accessories.
- 4) When charging with the charging pile, please use the charging pile correctly and pay attention to the high-voltage danger.

### Danger of tip-over

Battery weighing less than the original battery cannot be used. The battery not only acts as a counterweight in the chassis, but also is essential to maintain the stability of the machine. The weight of each battery pack must reach 130kg (T20JE/T22JE);185Kg(T26JE/T28JE).

### Danger during lifting

When raising the battery, please use the appropriate number and lifting method.

## 1.17 Locked after Each Use

- 1) Choose a safe parking place, which can be a solid level ground without obstacles and avoid places where transportation is busy.
- 2) Indent and lower the boom to the stowed position.
- 3) Rotate the rotary table so that the boom is located between the two tire of the rear axle.
- 4) Turn the key switch to the "off" position and remove the key to avoid unauthorized use.
- 5) Cushion the wheel with a wedge.
- 6) Charge the battery. (If required)

## 1.18 Personal Fall Protection

- 1) The personal fall protection equipment (PFPE) is required when this machine is operated.
- 2) Personnel on the platform must wear a seat

belt or use safety facilities that comply with government regulations. Tie the lanyard to the lanyard fixing point of the platform.

- 3) Users must abide by user rules, workplace rules and government rules regarding the use of personal protection equipment.
- 4) All PFPEs must comply with the corresponding government regulations and must be inspected and used according to the PFPE manufacturer's instructions.

## 1.19 Ground Information



**WARNING: Rollover and personal**

**injury will be caused under severe working conditions and complex and unsafe ground conditions, and stable ground conditions and good working conditions can ensure the normal operation of the machine; therefore before operation, verify that the ground in the working area is safe and strong enough to support the machine.**



**DANGER: Rollover and personal**

**injury may occur under the following conditions:**

- on steep slopes or in caves;
- when there are protrusions, obstacles or debris on the ground;
- on the inclined surface;
- on the unstable or smooth surface;
- near the mining area where the soil foundation is soft soil;
- on saturated soil or frozen soil;
- on suspended floor;
- on kerbs and road edges;

- on surface support that is not strong enough to withstand the full load of the machine;
- under other possible unsafe situations.

The ground load bearing information of the machine is shown in the table below:

Model	Tire contact pressure (kPa)	Occupied floor pressure (Kpa)
T20JE	670	12.9
T22JE	652	14.2
T26JE	899	18.2
T28JE	903	18.9

Table 1-4 Ground load bearing information



**CAUTION:** The ground load bearing information given herein is for reference only, and does not consider the optional devices of the machine. Before using the machine, always verify that the ground of the working area is safe and strong enough to support the machine.

**Tire specification:**

Model	Drive wheel load-5km/h (Kg)	Maximum static load (Kg)
T20JE	5300	7000
T22JE	5300	7000
T26JE	8750	10500
T28JE	8750	10500

Table 1-5 Tire specification



## Chapter 2 Legend



**! CAUTION:** The product structure diagram of T20JE is shown here. For other models, please refer to this diagram.

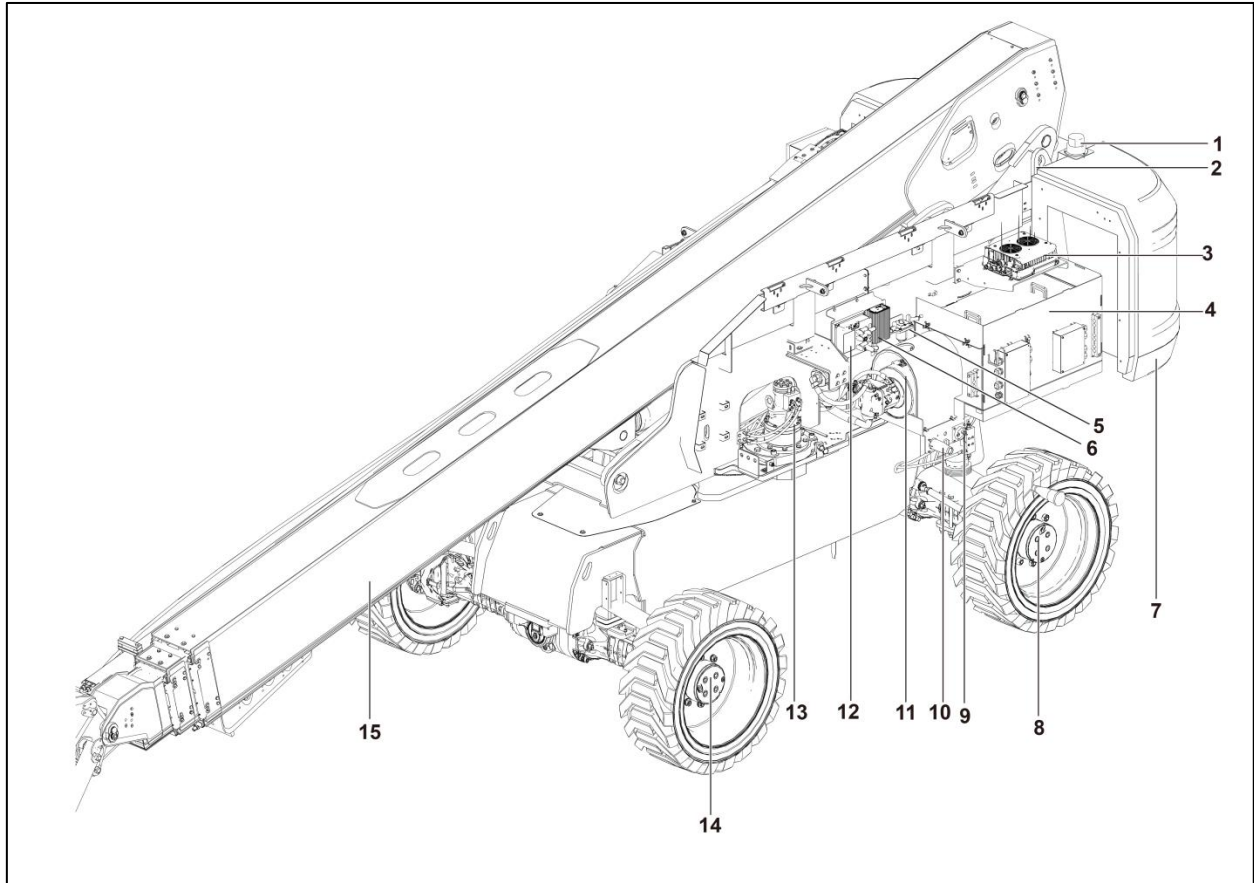

Fig. 2-1 Complete machine chart

No.	Name	No.	Name
1	Warning lamp	9	DC Charging plug (If equipped)
2	Lifting fixed point	10	AC charging plug
3	Charger	11	Pump motor
4	Lithium battery pack	12	Motor controller of pump
5	DC contactor	13	Slewing reducer
6	DC converter	14	Rear axle
7	Counterweight	15	Boom
8	Front axle		

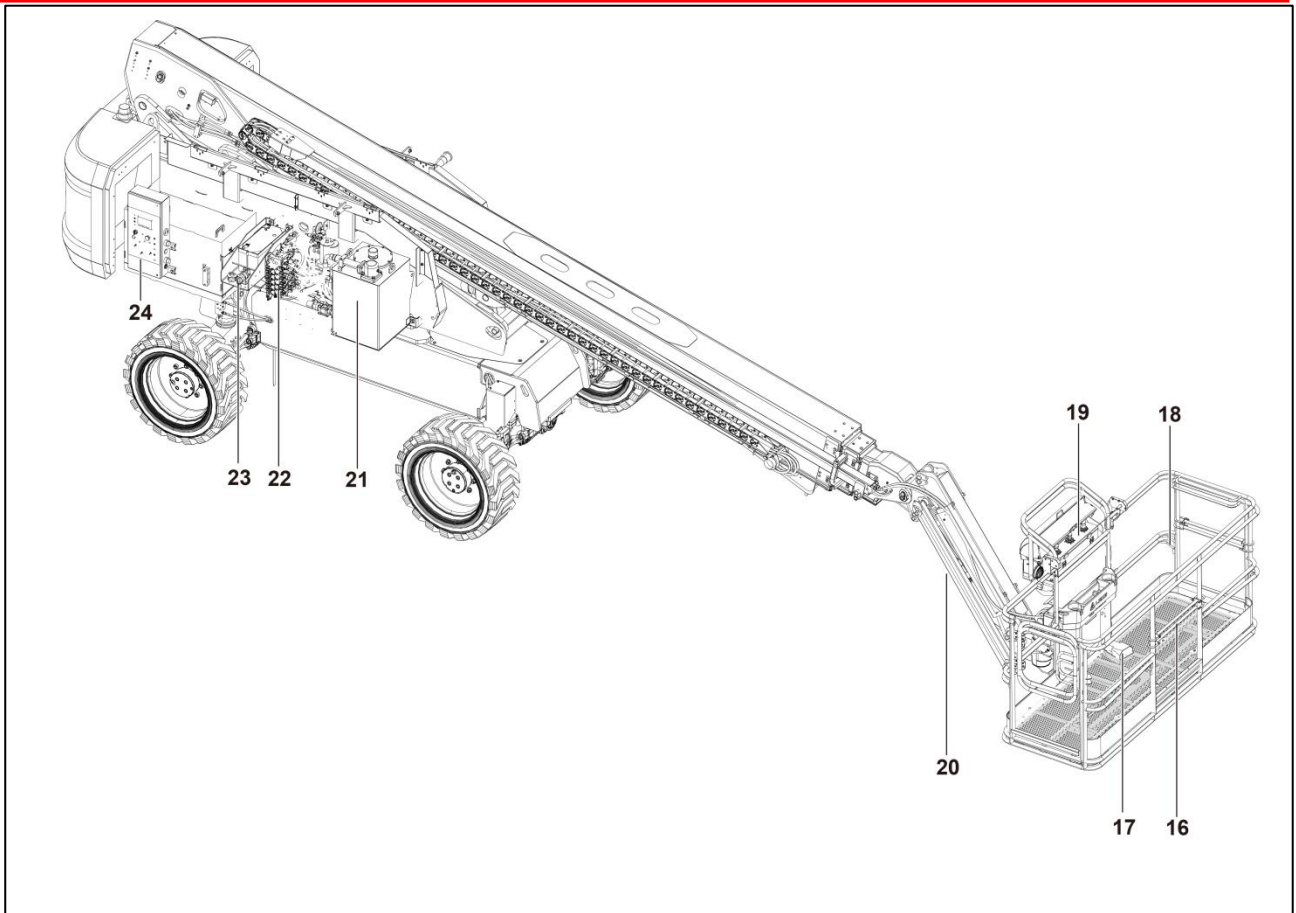

Fig. 2-2

No.	Name	No.	Name
16	Lifting cross bar	21	Hydraulic tank
17	Foot switch	22	Main valve
18	Lanyard anchorage point	23	DC power switch
19	PCU assembly	24	GCU assembly
20	Jib boom		

## Chapter 3 Label



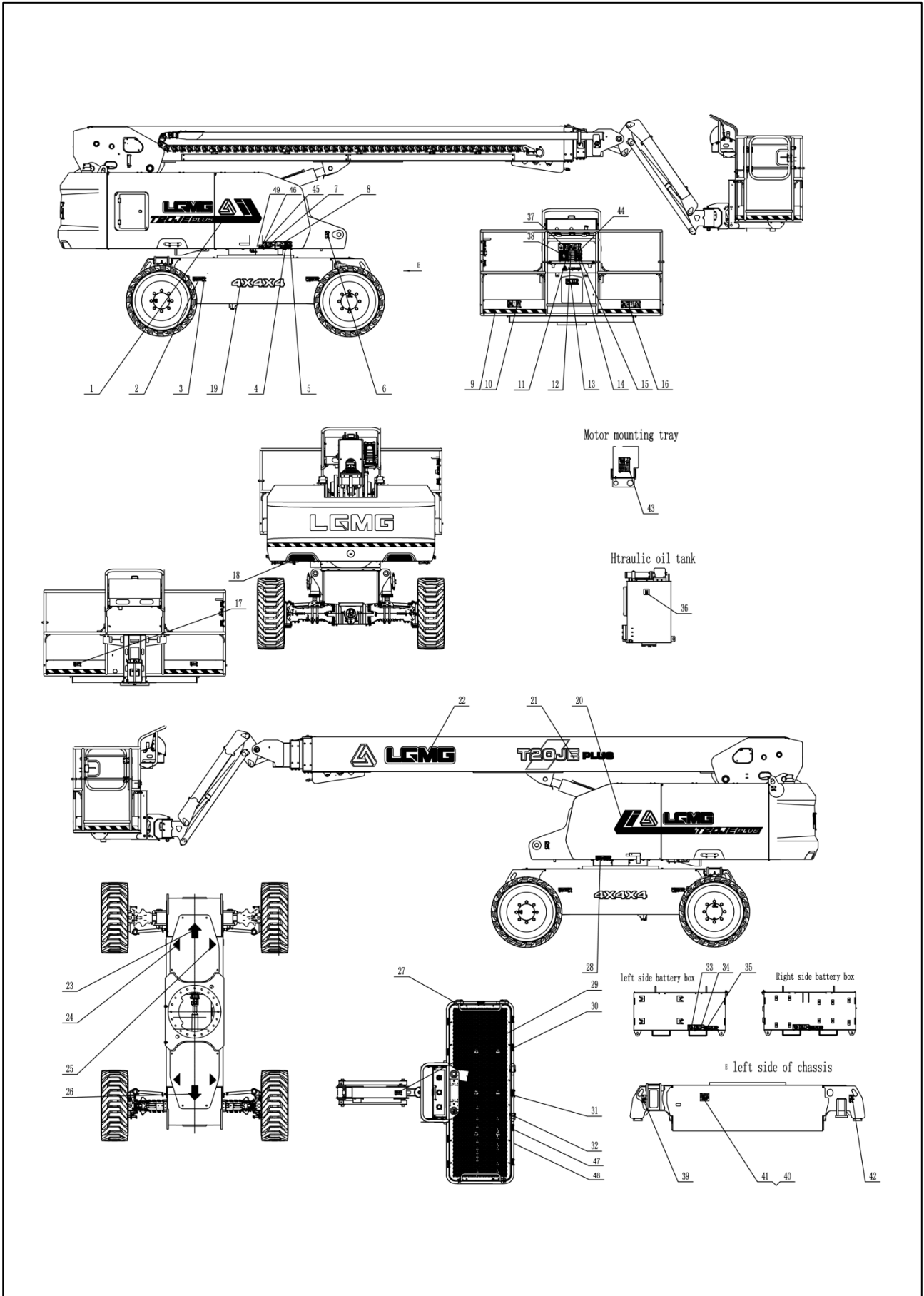

Fig. 3-1 Label position

T20JE/T22JE/T26JE/T28JE (Plus) sign details









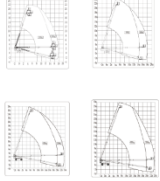

Code	Coding	Name	Code	Coding	Name
1	2534003239 2534003264 2534003412 2534003414	Decal-Hood-left	25	2534000050	Decal-Arrow
2	2534000045	Decal-“Replace tire” warning	26	2534000052	Decal-Arrow
3	2534002692 2534001752	Decal-Wheel load	27	2534001809	Decal-Anti-scratch sticker
4	2534000026	Decal- “Read manual” warning	28	2534000011	Decal-In-box maintenance warning
5	2534000047	Decal-No smoking warning	29	2534000042	Decal-Falling hazard
6	2534000043	Decal-Crushing hazard	30	2534000017	Decal-Decal-Lanyard fixing point
7	2534000004	Decal-Explosion burn warning	31	2534000036	Decal-Lowering middle column warning
8	2534000048	Decal-Electric shock warning	32	2534000248	Decal-Anti-scratch sticker
9	2534000024	Decal-Warning line	33	2534000124	Decal-Warning for prohibiting water spraying
10	2534000037	Decal-Outdoor hand power	34	2534000004	Decal-Explosion burn warning
11	2534000040	Decal-Tip-over warning when going uphill and downhill	35	2534000062	Decal-Warning sign for using batteries as counterweight
12	2534000145	Decal-Warning	36	2534001995	Decal-Hydraulic tank
13	2534000119	Decal- “Read manual” warning	37	2534002550	Decal-Ramp driving instructions
14	2534000247	Decal-Electric shock hazard	38	2534002696 2534003019 2534002743 2534002936	Decal-Working curve -double load
15	2534000039	Decal-Tip-over warning	39	2831990027	Decal-Lug
16	2534001502	Decal-Double load	40	4019000012	Rivet
17	2534000041	Decal-Keeping away from machine warning	41	2534003420	Decal-Complete machine nameplate
18	2534002657	Decal-Reflective stickers	42	2534000027	Decal-Lifting
19	2534003143	Decal-4*4*4	43	2534003244	Decal-Charging indication
20	2534003240 2534003265	Decal-Hood-right	44	2534003243	Decal-Instructions for use of differential lock

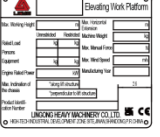

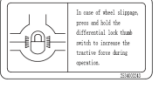
	2534003413 2534003415				
21	2534003185 2534003142 2534003188 2534003191	Decal-Model	45	2534000276	Decal-CE
22	2534003241	Decal-Company LOGO	46	2534003337	Decal-Power supply switch
23	2534000053	Decal-Arrow	47	2534003641	Decal-hand-hold position
24	2534000051	Decal-Arrow	48	2534003478	Decal-Risk of pinching hand
			49	2534004014	Decal-UKCA

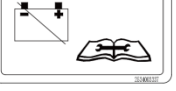
## T20JE/T22JE/T26JE/T28JE (Plus) sign

1-2534003239/64/3412/3414	2-2534000045	3-2534002692/1752	4-2534000026	5-2534000047	6-2534000043
7-2534000004	8-2534000048	9-2534000024	10-2534000037	11-2534000040	12-2534000145
					<p><b>WARNING</b> THIS MACHINE MUST NOT BE USED UNTIL IT IS INSPECTED AND OPERATING PROPERLY. 1 Do not operate, repair and maintenance on the platform unless you are trained and qualified. 2 Any failure to duty rules in operation, repair and maintenance can result in injury and death. 3 Do not perform operation, repair and maintenance procedures unless you read, understand the manual completely. 4 To avoid fire or electrical accidents, any components due to contact or unauthorized modification shall be responsible for the users. 5 The operation procedures and precautions referred to herein are only applicable to the stipulated operation of the machine. Be always ensured that any operation not of the specification is not permitted at all not for anyone.</p>
13-2534000119	14-2534000247	15-2534000039	16-2534001502	17-2534000041	18-2534002657
19-25340003143	20-2534003240/65/3413/3415	21-2534003185/42/88/91	22-2534003241	23-2534000053	24-2534000051
25-2534000050	26-2534000052	27-2534001809	28-2534000011	29-2534000042	30-2534000017
31-2534000036	32-2534000248	33-2534000124	34-2534000004	35-2534000062	36-2534001995

37-2534002550	38-2534002696/2534003019 2534002743/2534002936	39-2831990027	40/41-2534004110	42-2534000027	43-2534003244
					
44-2534003243	45-2534000276	46-2534003337	47-2534003641	48-2534003478	49-2534004014
					



## **Chapter 4 Overall Machine Parameters**



## T20JE (T2017J0WDQ0CE7000) overall parameters

### 4.1 Overall performance parameters

Item	Parameters	Item	Parameters	
Rated load (kg)	300	Rotary table slewing time per circle (stowed) (S)	78-86	
	2 people +140 kg	Rotary table slewing time per circle (The boom extends to 12m) (S)	115-130	
Limiting load (Kg)	450	Rise time of main boom (S)	60-70	
	3 people +210 kg	Drop time of main boom (S)	60-70	
Overall weight (kg)	12000	Boom extension time (S)	58-66	
Maximum working height (m)	21.8	Boom retraction time (S)	53-62	
Maximum platform height (m)	19.8	Jib boom lifting time (S)	40-50	
Maximum horizontal extension (m)	16.6	Jib boom lowering time (S)	20-35	
Minimum turning radius (four wheels) (inner wheels) (m)	1.9	Platform slewing time (S)	13-26	
Minimum turning radius (four wheels) (outer wheels) (m)	3.9	Maximum manual force (N)	400	
Maximum driving speed (no-load, stowed) (km/h)	5±0.25	Maximum allowable wind speed (m/s)	12.5	
Maximum driving speed (deployment) (km/h)	0.8±0.05	Maximum allowable inclination angle of chassis	Along the boom	5°
Maximum braking distance (no-load, stowed) (m)	1≤S≤1.5		Orthogonal to boom	5°
Theoretical maximum climbing ability (no-load, stowed)	45%	Driving type	Four-wheel drive	
			Four-wheel steering	

### 4.2 Main dimensions

Item	Parameters	Item	Parameters
Overall length (mm)	10200	Wheelbase (mm)	2510
Overall width (mm)	2500	Wheel track (mm)	2140
Overall height (mm)	2765	Ground clearance (mm)	400
Dimensions of working platform (LxW) (mm)	2440×900	Tire Spec. (Diameter×width) (mm)	940×350

### 4.3 Drive system

Item		Parameters/Content
Front axle	Speed ratio	21.81: 1
	Brake type	Multi-disc wet braking
Rear axle	Speed ratio	21.81: 1
	Brake type	Multi-disc wet braking

#### 4.4 Hydraulic system

Item		Parameters/Content	
Functional system	Type	Open system	
	Pump displacement (ml/r)	28	
	Lifting system	Maximum working pressure (MPa)	22
	Slewing system	Maximum working pressure (MPa)	9
		Motor displacement (ml/r)	80
Steering system	Maximum working pressure (MPa)	18	

#### 4.5 Electric system

Item		Parameters/Content
Drive motor	Rated voltage (V)	54
	Rated current (A)	239
	Rated power (kW)	18
	Rated speed (r/min)	3243
Pump motor	Rated voltage (V)	56
	Rated current (A)	314
	Rated power (kW)	24
	Rated speed (r/min)	2150
Battery	Output voltage (V)	77.8
	Capacity (Ah)	375
Charger	Nominal AC input voltage (V)	100-240
	Maximum AC input current (A)	32
	Nominal DC Output Voltage (V)	80
	Maximum DC Output Current (A)	80
Control system	Voltage (V)	12

#### 4.6 Filling volume

Item	Condition	Grade	Capacity	Remarks
Hydraulic oil	/	Rando MV32	100L	Chevron



Gear box	30°C < Minimum temperature	85W/140	1.2L	API GL-5
	-10°C < Minimum temperature <30°C	85W/90		
Front axle, rear axle	-30°C < Minimum temperature <-10°C	80W/90	9.6L x2	
	Minimum temperature <-30°C	75W		
Slewing reducer	30°C < Minimum temperature	85W/140	1.3L	API GL-5
	-10°C < Minimum temperature <30°C	85W/90		
	-30°C < Minimum temperature <-10°C	80W/90		
	Minimum temperature <-30°C	75W		
Inner raceway of slewing bearing	/	Lithium base grease 2#	Appropriate amount	/
Surface of slewing gear and slewing bearing	/	Lithium base grease 2#	Appropriate amount	/

#### 4.7 Scope of work

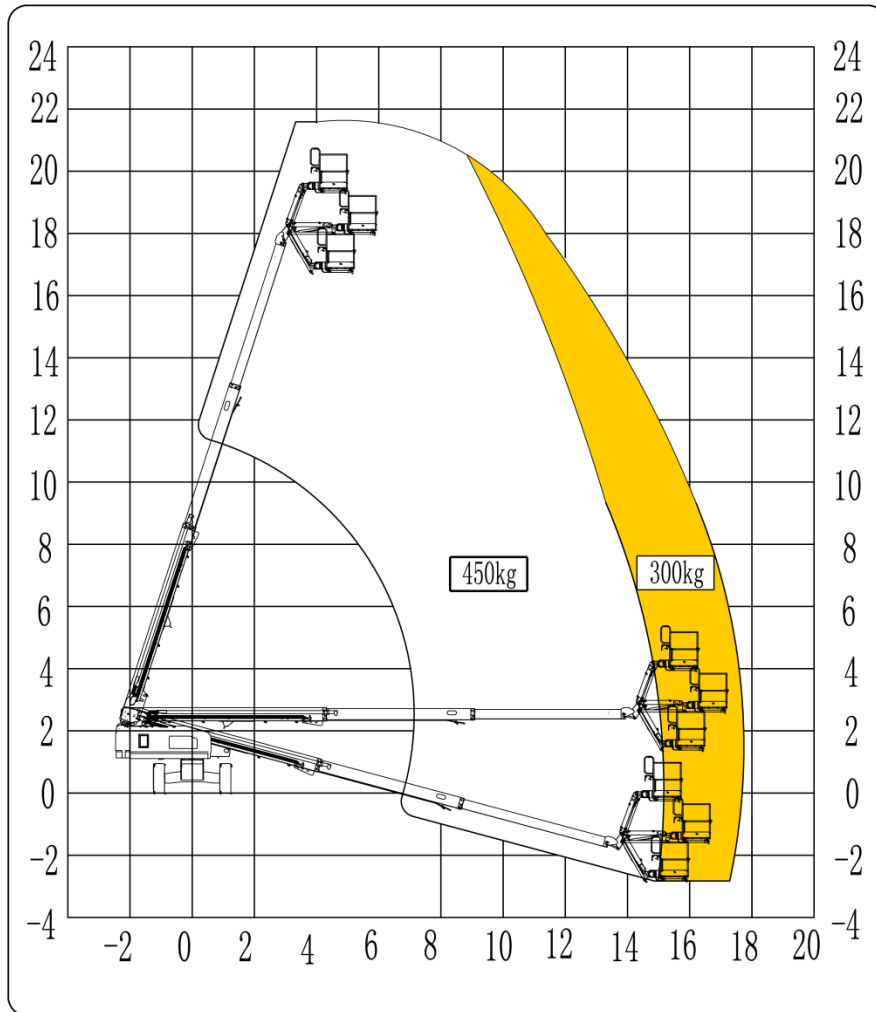

##### Sequence of operation:

When operating with a ground controller: the machine motion range is automatically controlled according to the load on the platform.

When the platform load is less than 300Kg, T20JE motion range is not restricted.

When the platform load is greater than 300Kg and less than 450Kg, T20JE motion range is restricted.

When operating with the platform controller: the machine motion range is controlled by the load selection button switch of the platform controller.

Turn the dial button switch to 300Kg: the rated load of the machine is 300Kg, and the motion range of T20JE is not restricted.

Turn the dial button switch to 450Kg: the restricted load of the machine is 450Kg, and the motion range of T20JE is restricted.

**T22JE (T2217J0WDQ0CE7000) Overall parameters**

**4.1 Overall performance parameters**

Item	Parameters	Item	Parameters	
Rated load (kg)	300	Rotary table slewing time per circle (stowed) (S)	80-90	
	2 people +140 kg	Rotary table slewing time per circle (The boom extends to 13.3m) (S)	135-150	
Limiting load (Kg)	450	Rise time of main boom (S)	60-70	
	3 people +210 kg	Drop time of main boom (S)	60-70	
Overall weight (kg)	12300	Boom extension time (S)	65-75	
Maximum working height (m)	23.8	Boom retraction time (S)	60-70	
Maximum platform height (m)	21.8	Jib boom lifting time (S)	40-50	
Maximum horizontal extension (m)	16.6	Jib boom lowering time (S)	20-35	
Minimum turning radius (four wheels) (inner wheels) (m)	1.9	Platform slewing time (S)	13-26	
Minimum turning radius (four wheels) (outer wheels) (m)	3.9	Maximum manual force (N)	400	
Maximum driving speed (stowed)(km/h)	5±0.25	Maximum allowable wind speed (m/s)	12.5	
Maximum driving speed (deployment) (km/h)	0.8±0.05	Maximum allowable inclination angle of chassis	Along the boom	5°
Maximum braking distance (no-load, stowed) (m)	1≤S≤1.5		Orthogonal to boom	5°
Theoretical maximum climbing ability (no-load, stowed)	45%	Driving type	Four-wheel drive	
			Four-wheel steering	

**4.2 Main dimensions**

Item	Parameters	Item	Parameters
Overall length (mm)	11000	Wheelbase (mm)	2510
Overall width (mm)	2500	Wheel track (mm)	2140
Overall height (mm)	2765	Ground clearance (mm)	400
Dimensions of working platform (LxW) (mm)	2440x900	Tire Spec. (Diameter×width) (mm)	940×350

**4.3 Drive system**

Item	Parameters/Content

Front axle	Speed ratio	21.81: 1
	Brake type	Multi-disc wet braking
Rear axle	Speed ratio	21.81: 1
	Brake type	Multi-disc wet braking

#### 4.4 Hydraulic system

Item		Parameters/Content	
Functional system	Type	Open system	
	Pump displacement (ml/r)	28	
	Lifting system	Maximum working pressure (MPa)	22
	Slewing system	Maximum working pressure (MPa)	9
		Motor displacement (ml/r)	80
Steering system	Maximum working pressure (MPa)	18	

#### 4.5 Electric system

Item		Parameters/Content
Drive motor	Rated voltage (V)	54
	Rated current (A)	239
	Rated power (kW)	18
	Rated speed (r/min)	3243
Pump motor	Rated voltage (V)	56
	Rated current (A)	314
	Rated power (kW)	24
	Rated speed (r/min)	2150
Battery	Output voltage (V)	77.8
	Capacity (Ah)	375
Charger	Nominal AC input voltage (V)	100-240
	Maximum AC input current (A)	32
	Nominal DC Output Voltage (V)	80
	Maximum DC Output Current (A)	80
Control system	Voltage (V)	12

#### 4.6 Filling volume

Item	Condition	Grade	Capacity	Remarks
Hydraulic oil	/	Rando MV32	100L	Chevron
Gear box	30°C < Minimum temperature	85W/140	1.2L	API GL-5

Front axle, rear axle	-10°C < Minimum temperature <30°C	85W/90	9.6L x2	
	-30°C < Minimum temperature <-10°C	80W/90		
	Minimum temperature <-30°C	75W		
Slewing reducer	30°C < Minimum temperature	85W/140	1.3L	API GL-5
	-10°C < Minimum temperature <30°C	85W/90		
	-30°C < Minimum temperature <-10°C	80W/90		
	Minimum temperature <-30°C	75W		
Inner raceway of slewing bearing	/	Lithium base grease 2#	Appropriate amount	/
Surface of slewing gear and slewing bearing	/	Lithium base grease 2#	Appropriate amount	/

#### 4.7 Scope of work

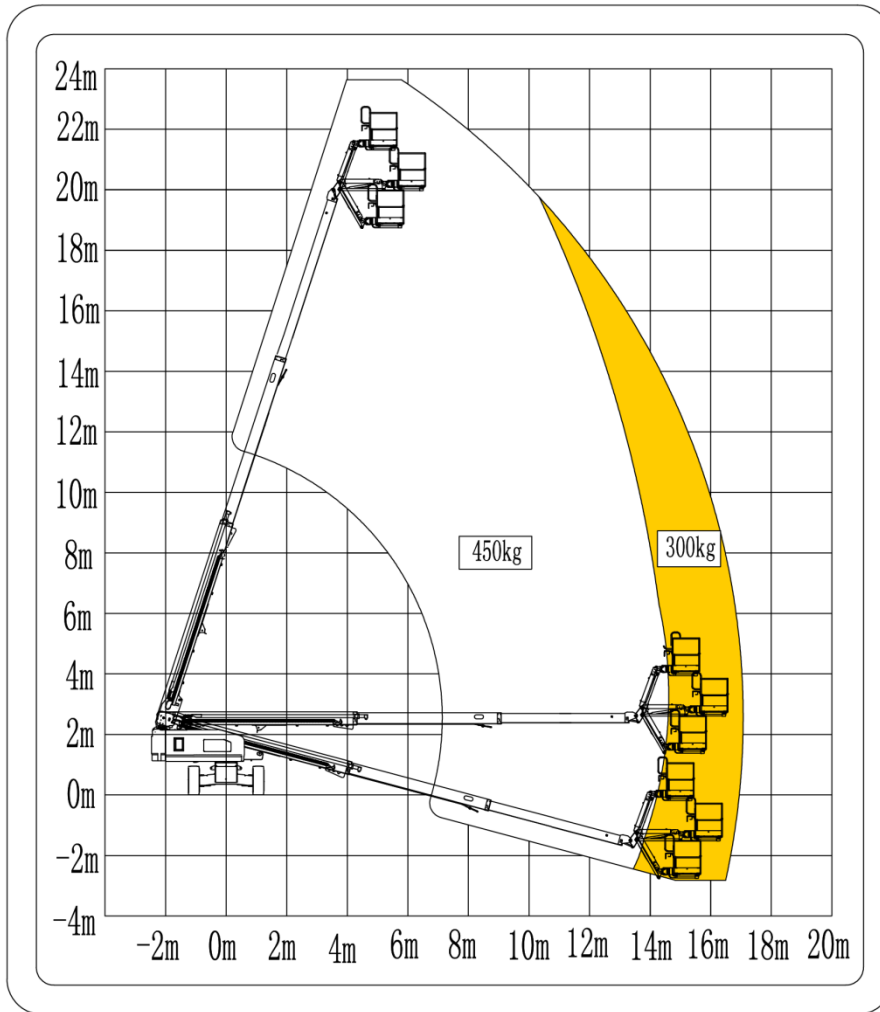

##### Sequence of operation:

When operating with a ground controller: the machine motion range is automatically controlled according to the load on the platform.

When the platform load is less than 300Kg, T22JE motion range is not restricted.

When the platform load is greater than 300Kg and less than 450Kg, T22JE motion range is restricted.

When operating with the platform controller: the machine motion range is controlled by the load selection button switch of the platform controller.

Turn the dial button switch to 300Kg: the rated load of the machine is 300Kg, and the motion range of T22JE is not restricted.

Turn the dial button switch to 450Kg: the restricted load of the machine is 450Kg, and the motion range of T22JE is restricted.

**T26JE (T2622J0WDQ0CE7000) Overall parameters**

**4.1 Overall performance parameters**

Item	Parameters	Item	Parameters
Rated load (kg)	300	Rotary table slewing time per circle (stowed) (S)	95-115
	2 people +140 kg	Rotary table slewing time per circle (The boom extends to 16.3m) (S)	160-175
Limiting load (Kg)	450	Rise time of main boom (S)	70-90
	3 people +210 kg	Drop time of main boom (S)	70-90
Overall weight (kg)	18200	Boom extension time (S)	55-73
Maximum working height (m)	27.9	Boom retraction time (S)	55-73
Maximum platform height (m)	25.9	Jib boom lifting time (S)	40-50
Maximum horizontal extension (m)	21.6	Jib boom lowering time (S)	20-35
Minimum turning radius (four wheels) (inner wheels) (m)	2.04	Platform slewing time (S)	13-26
Minimum turning radius (four wheels) (outer wheels) (m)	4.13	Maximum manual force (N)	400
Maximum driving speed (stowed)(km/h)	5±0.25	Maximum allowable wind speed (m/s)	12.5
Maximum driving speed (deployment) (km/h)	0.8±0.05	Maximum allowable inclination angle of chassis	Along the boom 5°
Maximum braking distance (no-load, stowed) (m)	1≤S≤1.5		Orthogonal to boom 5°
Theoretical maximum climbing ability (no-load, stowed)	45%	Driving type	Four-wheel drive
			Four-wheel steering

**4.2 Main dimensions**

Item	Parameters	Item	Parameters
Overall length (mm)	12800	Wheelbase (mm)	2850
Overall width (mm)	2500	Wheel track (mm)	2110
Overall height (mm)	2815	Ground clearance (mm)	400
Dimensions of working platform (LxW) (mm)	2440x900	Tire Spec. (Diameter×width) (mm)	1000x388

**4.3 Drive system**

Item	Parameters/Content

Front axle	Speed ratio	21.81: 1
	Brake type	Multi-disc wet braking
Rear axle	Speed ratio	21.81: 1
	Brake type	Multi-disc wet braking

#### 4.4 Hydraulic system

Item		Parameters/Content	
Functional system	Type	Open system	
	Pump displacement (ml/r)	28	
	Lifting system	Maximum working pressure (MPa)	20
	Slewing system	Maximum working pressure (MPa)	9
		Motor displacement (ml/r)	80
Steering system	Maximum working pressure (MPa)	18.5	

#### 4.5 Electric system

Item		Parameters/Content
Drive motor	Rated voltage (V)	54
	Rated current (A)	239
	Rated power (kW)	18
	Rated speed (r/min)	3243
Pump motor	Rated voltage (V)	56
	Rated current (A)	314
	Rated power (kW)	24
	Rated speed (r/min)	2150
Battery	Output voltage (V)	77.28
	Capacity (Ah)	542
Charger	Nominal AC input voltage (V)	100-240
	Maximum AC input current (A)	32
	Nominal DC Output Voltage (V)	80
	Maximum DC Output Current (A)	80
Control system	Voltage (V)	12

#### 4.6 Filling volume

Item	Condition	Grade	Capacity	Remarks
Hydraulic oil	/	Rando MV32	105L	Chevron
Gear box	30°C < Minimum temperature	85W/140	1.2L	API GL-5



Front axle, rear axle	-10°C < Minimum temperature <30°C	85W/90	9.6L ×2	
	-30°C < Minimum temperature <-10°C	80W/90		
	Minimum temperature <-30°C	75W		
Slewing reducer	30°C < Minimum temperature	85W/140	1.3L	API GL-5
	-10°C < Minimum temperature <30°C	85W/90		
	-30°C < Minimum temperature <-10°C	80W/90		
	Minimum temperature <-30°C	75W		
Inner raceway of slewing bearing	/	Lithium base grease 2#	Appropriate amount	/
Surface of slewing gear and slewing bearing	/	Lithium base grease 2#	Appropriate amount	/

#### 4.7 Scope of work

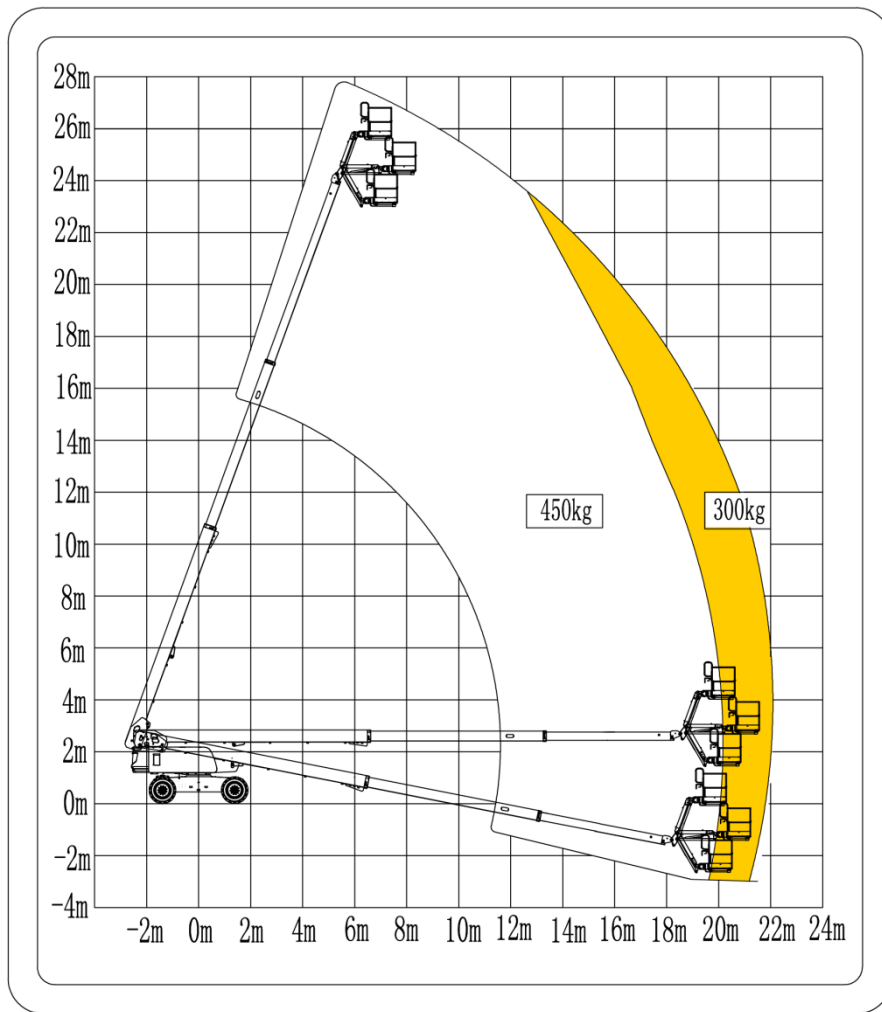

Sequence of operation:

When operating with a ground controller: the machine motion range is automatically controlled according to the load on the platform.

When the platform load is less than 300Kg, T26JE motion range is not restricted.

When the platform load is greater than 300Kg and less than 450Kg, T26JE motion range is restricted.

When operating with the platform controller: the machine motion range is controlled by the load selection button switch of the platform controller.

Turn the dial button switch to 300Kg: the rated load of the machine is 300Kg, and the motion range of T26JE is not restricted.

Turn the dial button switch to 450Kg: the restricted load of the machine is 450Kg, and the motion range of T26JE is restricted.

**T28JE (T2823J0WDQ0CE7000) Overall parameters**

**4.1 Overall performance parameters**

Item	Parameters	Item	Parameters
Rated load (kg)	300	Rotary table slewing time per circle (stowed) (S)	100-120
	2 people +140 kg	Rotary table slewing time per circle (extended) (The boom extends to 17.5m) (S)	170-190
Limiting load (Kg)	450	Rise time of main boom (S)	80-100
	3 people +210 kg	Drop time of main boom (S)	80-100
Overall weight (kg)	18700	Boom extension time (S)	64-77
Maximum working height (m)	29.8	Boom retraction time (S)	62-75
Maximum platform height (m)	27.8	Jib boom lifting time (S)	40-50
Maximum horizontal extension (m)	21.6	Jib boom lowering time (S)	20-35
Minimum turning radius (four wheels) (inner wheels) (m)	2.04	Platform slewing time (S)	13-26
Minimum turning radius (four wheels) (outer wheels) (m)	4.13	Maximum manual force (N)	400
Maximum driving speed (stowed)(km/h)	5±0.25	Maximum allowable wind speed (m/s)	12.5
Maximum driving speed (deployment) (km/h)	0.8±0.05	Maximum allowable inclination angle of chassis	Along the boom 5°
Maximum braking distance (no-load, stowed) (m)	1≤S≤1.5		Orthogonal to boom 5°
Theoretical maximum climbing ability (no-load, stowed)	45%	Driving type	Four-wheel drive
			Four-wheel steering

**4.2 Main dimensions**

Item	Parameters	Item	Parameters
Overall length (mm)	13400	Wheelbase (mm)	2850
Overall width (mm)	2500	Wheel track (mm)	2110
Overall height (mm)	2815	Ground clearance (mm)	400
Dimensions of working platform (LxW) (mm)	2440x900	Tire Spec. (Diameter×width) (mm)	1000x388

**4.3 Drive system**

Item	Parameters/Content

Front axle	Speed ratio	21.81: 1
	Brake type	Multi-disc wet braking
Rear axle	Speed ratio	21.81: 1
	Brake type	Multi-disc wet braking

#### 4.4 Hydraulic system

Item		Parameters/Content	
Functional system	Type	Open system	
	Pump displacement (ml/r)	28	
	Lifting system	Maximum working pressure (MPa)	20
	Slewing system	Maximum working pressure (MPa)	9
		Motor displacement (ml/r)	80
Steering system	Maximum working pressure (MPa)	18.5	

#### 4.5 Electric system

Item		Parameters/Content
Drive motor	Rated voltage (V)	54
	Rated current (A)	239
	Rated power (kW)	18
	Rated speed (r/min)	3243
Pump motor	Rated voltage (V)	56
	Rated current (A)	314
	Rated power (kW)	24
	Rated speed (r/min)	2150
Battery	Output voltage (V)	77.28
	Capacity (Ah)	542
Charger	Nominal AC input voltage (V)	100-240
	Maximum AC input current (A)	32
	Nominal DC Output Voltage (V)	80
	Maximum DC Output Current (A)	80
Control system	Voltage (V)	12

#### 4.6 Filling volume

Item	Condition	Grade	Capacity	Remarks
Hydraulic oil	/	Rando MV32	105L	Chevron
Gear box	30°C < Minimum temperature	85W/140	1.2L	API GL-5

Front axle, rear axle	-10°C < Minimum temperature <30°C	85W/90	9.6L ×2	
	-30°C < Minimum temperature <-10°C	80W/90		
	Minimum temperature <-30°C	75W		
Slewing reducer	30°C < Minimum temperature	85W/140	1.3L	API GL-5
	-10°C < Minimum temperature <30°C	85W/90		
	-30°C < Minimum temperature <-10°C	80W/90		
	Minimum temperature <-30°C	75W		
Inner raceway of slewing bearing	/	Lithium base grease 2#	Appropriate amount	/
Surface of slewing gear and slewing bearing	/	Lithium base grease 2#	Appropriate amount	/

#### 4.7 Scope of work

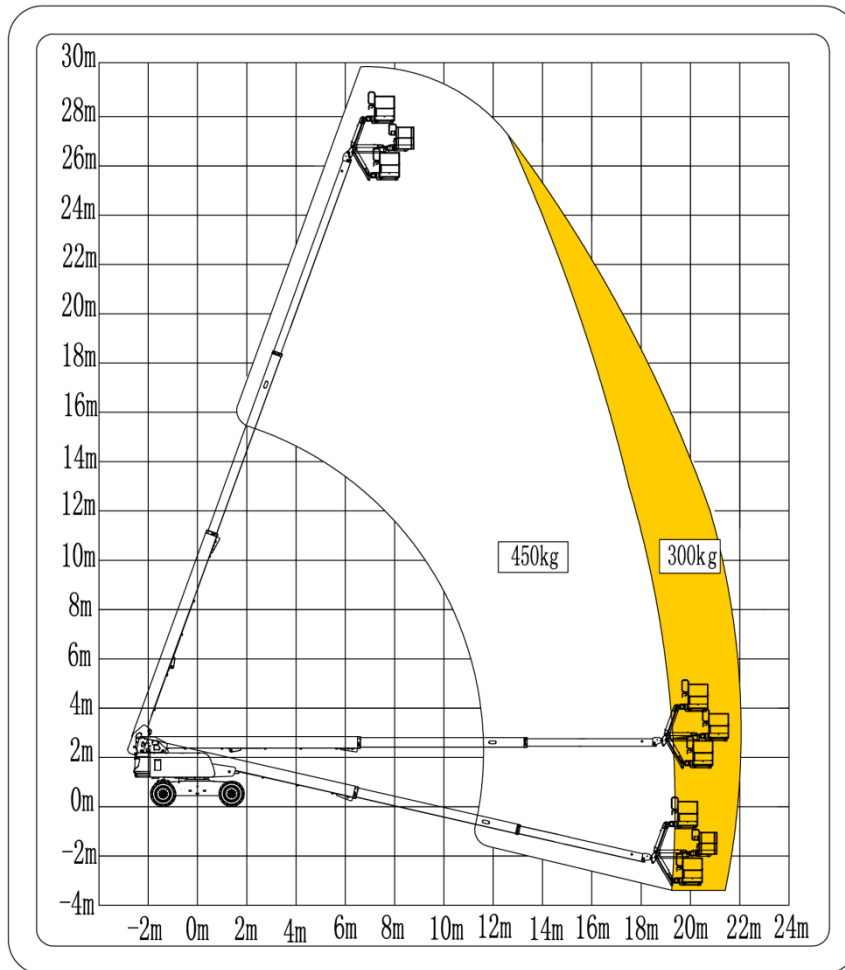

Sequence of operation:

When operating with a ground controller: the machine motion range is automatically controlled according to the load on the platform.

When the platform load is less than 300Kg, T28JE motion range is not restricted.

When the platform load is greater than 300Kg and less than 450Kg, T28JE motion range is restricted.

When operating with the platform controller: the machine motion range is controlled by the load selection button switch of the platform controller.

Turn the dial button switch to 300Kg: the rated load of the machine is 300Kg, and the motion range of T28JE is not restricted.

Turn the dial button switch to 450Kg: the restricted load of the machine is 450Kg, and the motion range of T28JE is restricted.

## Chapter 5 Control Box





## 5.1 GCU

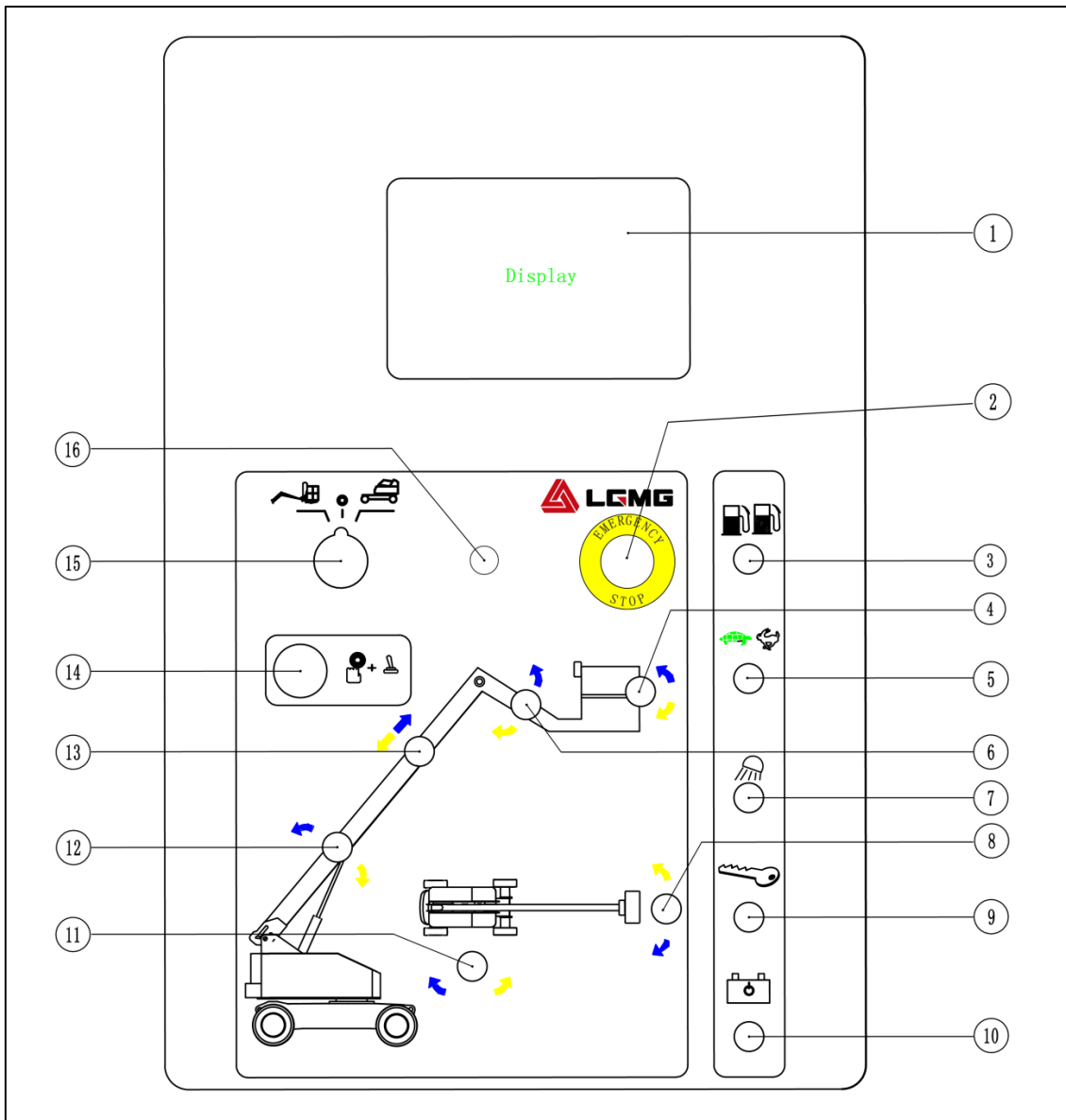

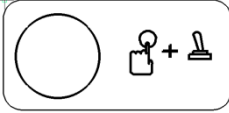



Figure 5-1 GCU panel

No.	Name	No.	Name
1	Display	9	Reserved
2	Emergency stop switch	10	Emergency power unit switch
3	Reserved	11	Rotary table slewing button
4	Platform leveling button	12	Boom up/down button
5	Reserved	13	Boom extension/retraction button
6	Jib boom lifting/lowering button	14	Function enable button
7	Lighting lamp (if equipped)	15	Key button switch
8	Platform rotary button	16	10A self-resetting fuse for control circuit

Table 5-1 Description of GCU panel functions

Table 5-2 The function description of the button switch of the GCU is shown in the table below:

Item	Button switch	Function description
GCU	Key button switch	 <p>Turn the key button switch to the platform position, and the PCU will run. Turn the key button switch to the OFF position and the machine will be turned off. Turn the key button switch to the chassis position. The GCU will run.</p>
	Emergency stop switch	 <p>All functions can be stopped by pushing the red "emergency stop" button inward to the "off" position; Turn the red "emergency stop" button to the on position. The machine can be operated, with the warning lamp flashing.</p>
	Function enabling button switch	 <p>All boom and platform functions will not run if the the function enabling button switch is not pressed and held; Press and hold the function enabling button switch, and activate the switch of each boom and platform function, so that all boom and platform functions can run.</p>
	Emergency power unit switch	 <p>If the main power source fails, use the emergency power unit. Activate the required function while keeping the emergency power unit switch on.</p>
	<ol style="list-style-type: none"> <li>1. Turn the key button switch to the GCU position.</li> <li>2. Turn the red "Emergency Stop" button outward to the ON position.</li> <li>3. Press and hold the function enabling button.</li> </ol>	
	Platform rotary button	<p>Pull up the platform rotary button switch, and the platform will rotate to the right; Pull down the platform rotary button switch, and the platform will rotate to the left.</p>
	Rotary table slewing button	<p>Turn the button switch to the right, and the rotary table will rotate to the right; Turn the button switch to the left and the rotary table will rotate to the left.</p>
	Boom up/down button	<p>Pull up the button switch, and the boom will rise; Pull down the button switch, and the boom will go down. When the boom is lowered, the buzzer shall sound; The buzzer will sound when the boom is luffed to the maximum and minimum positions.</p>
	Boom extension/retraction button	<p>Pull down the button switch, and the boom will be retracted; Pull up the button switch, and the boom will be extended. The buzzer will sound when the boom extends and retracts to the maximum position.</p>
	Jib boom lifting/lowering button	<p>Pull up the button switch, and the jib boom will rise; Pull down the button switch and the jib boom will drop.</p>
Platform leveling button	<p>Pull the platform leveling button upward, and the platform level will rise. When the platform leveling button is pulled down, the platform will descend.</p>	

## 5.2 PCU

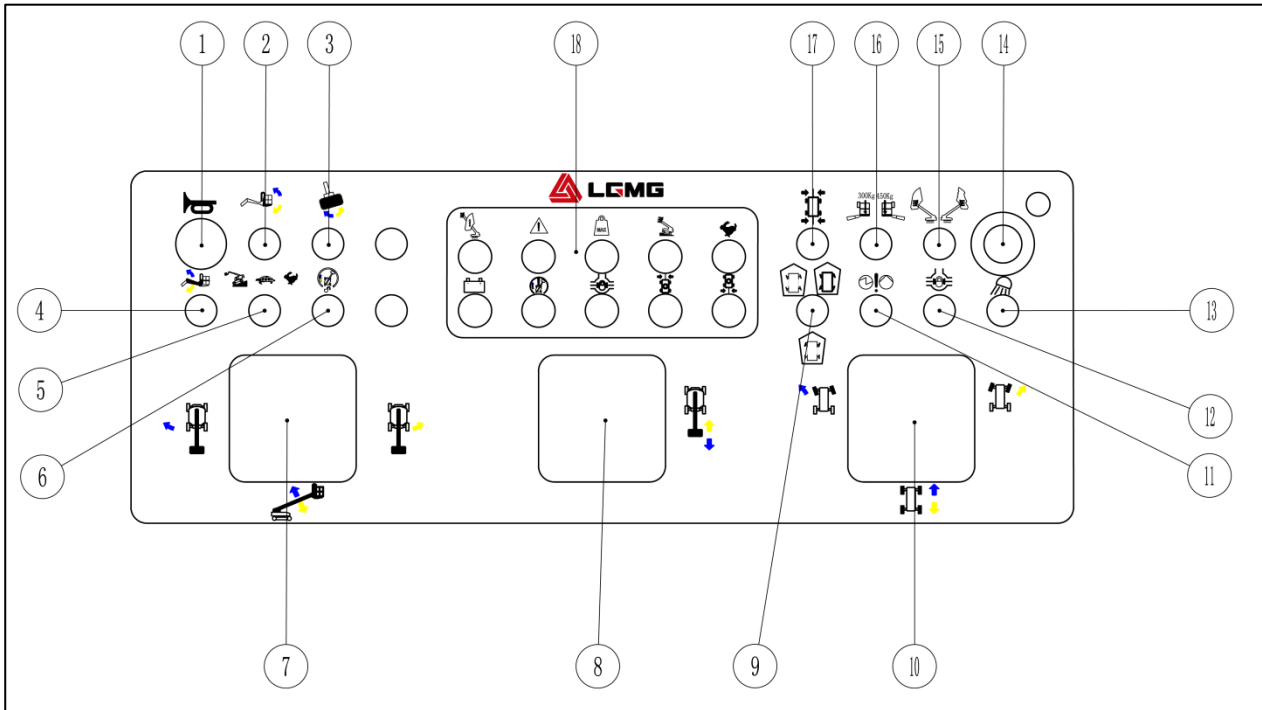



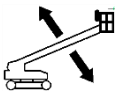







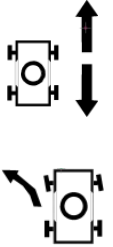
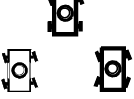
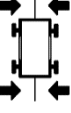

Figure 5-2 PCU panel

No.	Name	No.	Name
1	Horn button	10	Drive and steering control handle
2	Platform leveling button	11	Emergency power unit
3	Platform rotary button	12	Differential lock
4	Jib boom lifting/lowering button	13	Lighting lamp (if equipped)
5	Drive motor speed selection button	14	Emergency stop switch
6	Drive enabling button switch	15	Automatic retraction mode (reserved)
7	Boom lifting/lowering and rotary table slewing control handle	16	Load selection button
8	Boom extension/retraction control handle	17	Wheel automatic alignment
9	Crab steering/front wheel steering/four-wheel steering	18	Indicator lamp



Table 5-3 Name of Each Function of PCU Panel

Table 5-4 The function description of the button switch of the PCU is as follows:

Item	Button switch	Function description	
PCU	Emergency stop switch		Push the red "emergency stop" button inward to the OFF position to stop all PCU functions. Turn the red "emergency stop" button to the ON position to operate the machine on the PCU.
	Foot switch		Do not press down the pedal switch, and test each function of the machine. As a result, the machine function should not run. Depress the foot switch to activate the control handle or button switch for each function of the machine. All boom and platform functions shall be run for a full cycle.
	Emergency power unit		If the main power source fails, use the emergency power unit. Press the foot switch and activate the desired function while keeping the emergency power switch on. <b>CAUTION:</b> To save battery power, please test each function in part of a cycle. Result: all boom functions shall operate normally. The drive function shall not work with the emergency power supply.
	<ol style="list-style-type: none"> <li>1. Turn the key button switch to the PCU position.</li> <li>2. Turn the red "emergency shutdown" button outward to the ON position.</li> <li>3. Press down the foot switch.</li> </ol>		
	Platform rotary button		Turn the platform rotary button switch to the right, and the platform will rotate to the right. Move the button switch of the platform to the left, and the platform will rotate to the left.
	Boom lifting/lowering and rotary table slewing handle		Move the control handle to the right and the rotary table will move to the right. Move the control handle to the left and the rotary table will move to the left.
			Move the control handle up and the boom will rise; Move the control handle down and the boom will go down. When the boom is lowered, the buzzer shall sound; The buzzer will sound when the boom is luffed to the maximum and minimum positions.
	Boom telescopic handle		Move the control handle downward, and the boom will extend; Move the control handle upward and the boom will retract. The buzzer will sound when the boom extends and retracts to the maximum and minimum positions.
	Jib boom lifting/lowering button		Pull up the button switch, and the jib boom will rise; Pull down the button switch and the jib boom will drop.
	Platform leveling toggle switch		Pull the platform leveling toggle switch upward, and the platform horizontal plane will rise; When the platform leveling button is pulled down, the platform will descend.

Load selection button		<p>Turn the button switch to the left to select the rated load mode (the range of motion of the boom is not limited) or turn the button switch to the right to choose the limited load mode (the range of motion of the boom is limited). For details about the range of motion of the boom, see section 4.8.</p>
Drive motor speed selection button		<p>Turn the switch to the climbing gear, step on the foot switch, and the drive motor will run at low speed; Turn the switch to the turtle position, step on the foot switch, and the drive motor will run at middle speed; Turn the switch to the rabbit position, step on the foot switch, and the drive motor will run at high speed.</p>
Drive enable switch		<p>When the rotary table rotates to a certain angle, the drive function cannot operate, and the drive enable indicator lamp alarms. Turn the drive enable button switch to one side and release it, slowly move the driving function control handle. Result: The driving function shall operate.</p>
Drive/steering control handle		<p>Move the control handle upward, and the machine will drive forward; Move the control handle downward and the machine will drive backward. Press the left side of the thumb rocker. The front axle turns to the left, and the rear axle turns according to the four-wheel steering mode; Press the right side of the thumb rocker. The front axle turns to the right, and the rear axle turns according to the four-wheel steering mode.</p>
Steering mode selection button		<p>When the button is in the middle position, it is in the two-wheel steering mode, and only the front wheels are steering; When the button is turned to the left, the rear wheels turn in the same direction as the front wheels; When the torque is turned to the right, the rear wheel and the front wheel turn in the opposite direction.</p>
Wheel automatic alignment		<p>Turn the wheel automatic alignment button to the left, the wheels will be automatically aligned, and the rear and front wheel alignment indicator lamps will light up, indicating that the wheels have been aligned.</p>
Lighting lamp		<p>Flip the switch to turn the light on/off.</p>
Differential lock		<p>Toggle the differential lock switch and keep the differential lock continuously activated to increase the traction of the wheels on the rear axle. The differential light comes on after toggle the differential lock switch.</p>

The indicator lamp function description of the display panel is described in the following table:

	System fault alarm		Limited range of motion
-------------------------------------------------------------------------------------	--------------------	-------------------------------------------------------------------------------------	-------------------------









	Platform overload alarm		Machine tilt alarm
	Driver Enable Indication		Drive motor high speed mode
	Low battery indication		Indication after differential lock enabled
	Rear wheel alignment indication		Front wheel alignment indication

Table 5-5 Functional Description of LED Display Panel

## **Chapter 6 Pre-operation Inspection**





## 6.1 Before Performing This Operation, Ensure that

- 1) Equipped with PPE, such as helmet, safety belt, safety shoes, goggles, protective gloves, and in good physical condition.
- 2) You have understood and implemented the rules for safe operation of machines in this Operation Manual.
- 3) Avoid dangerous situations. Know and understand the safety rules before proceeding to the next step.
- 4) Check the workplace, please refer to the workplace inspection section of this manual.
- 5) Please read, understand and comply with all applicable government laws and regulations.
- 6) You are properly trained and qualified to operate the machine safely.
- 7) Only qualified maintenance technician can repair the machine according to the regulations of our company.

## 6.2 Basic Principles

- 1) Inspection and routine maintenance before performing operations are the responsibility of the operator.
- 2) The pre-operation inspection is a very intuitive inspection process, which is performed by the operator before each change of work. The purpose of the inspection is to find out whether there is an obvious problem with the machine before the operator performs the functional test.
- 3) Pre-operation checks can also be used to determine whether routine maintenance procedures are required. The operator can only perform routine maintenance items specified in this manual.
- 4) Please refer to the list on the next page and check each item.
- 5) If damage is found or any unlicensed change from the factory condition, the machine shall be marked and out of service.
- 6) Only qualified maintenance technician can

repair the machine. After the repair, the operator shall perform another pre-operation check before continuing the functional test.

- 7) According to the manufacturer's regulations and the requirements listed in the manual, the scheduled maintenance inspection shall be carried out by the qualified maintenance technician.

## 6.3 Pre-operation Inspection

- 1) Ensure that the manual is complete, easy to read, and kept in the file box of the platform. If the manual needs to be replaced, please contact LGMG service personnel.
- 2) Ensure that all labels are clear, legible and properly located. Please refer to the "label" section. If you need to replace the labels, please contact LGMG service personnel.
- 3) Check whether the ball valve at the oil suction port at the bottom of the hydraulic tank is open. It must be kept open unless there are special circumstances, and it must be open when the machine is in motion. If the valve is not opened when the machine is in motion, the oil pump will be completely damaged.
- 4) Please refer to the "Maintenance" section to check whether the hydraulic oil is leaking and whether the oil level is appropriate.
- 5) Check whether the battery wiring is secure.
- 6) Check the following components for damage, improper installation, loose or missing part and unauthorized alteration:
  - Electrical plugs, wiring and cables
  - Platform controllers, GCUs
  - Tilt sensors, length & angle sensors, weighing sensors
  - Displays, alarm indicator lamps, flashing lights, horns, buzzers, broken rope limit switches, drive-enabling limit switches
  - Valve block, hosepipe, hydraulic joint, cylinder, slewing motor and reducer
  - Hydraulic tank
  - Wear-resistant pad, tire, slewing bearing

- Nuts, bolts and other fasteners
  - Platform entrance lifting cross bar
  - Platform safety guard
  - Drive axle and motor
  - Battery and charger
- 7) Check the entire machine to find:
- Cracks in weld or structural parts
  - Dent or damage to the machine
  - Serious rust, corrosion or oxidation
  - Ensure that all structural parts and other key components are complete and all relevant fastener and pin are in the correct position and tightened,
  - After completing the inspection, make sure that the hood is in proper position and locked.

## **Chapter 7 Workplace Inspection**



## 7.1 Basic Principles

- 1) Workplace inspection helps the operator to determine whether the workplace can ensure the safe operation of the machine. The operator shall first perform this work before moving the machine to the workplace.
- 2) It is the operator's responsibility to understand and remember hazardous matters in the workplace, which can be noticed and avoided when moving, installing and operating the equipment.

## 7.2 Workplace Inspection

Pay attention to and avoid the following dangerous situations:

- Steep slope or cave
- Protrusions, ground barriers or debris
- Inclined surface
- Unfirm or smooth surface
- Air obstacles and high voltage wires
- Surface support insufficient to withstand the full load force exerted by the machine
- The instantaneous wind speed exceeds 12.5 m/s
- Use ambient temperature and humidity beyond the required temperature and humidity requirements
- Unauthorized personnel appear
- Other possible unsafe situations



## **Chapter 8 Functional Testing**





## 8.1 Basic Principles

- 1) You have understood and implemented the rules for safe operation of machines in this Operation Manual.
- 2) PPE, such as helmets, seat belts, safety shoes, goggles, etc., have been equipped according to site needs and are in good physical condition.
- 3) Select a solid, level and barrier-free test area.
- 4) Avoid dangerous situations. Know and understand the safety rules before proceeding to the next step.
- 5) Functional testing is used to detect faults before starting to use the machine.
- 6) The operator must test all functions of the machine according to the procedure instructions.
- 7) Do not use the faulty machine. If a fault is found, the machine must be marked and stopped to use.
- 8) Only qualified maintenance technician are allowed to repair the machine according to our company's regulations.
- 9) After the repair, the operator must perform the pre-operation inspection and function test again before starting to use the machine.

## 8.2 At GCU

Turn the key switch to the GCU position.

Turn the red "emergency stop" button out to the "on" position, and the alarm lamp starts to flash.

- 1) Test emergency shutdown
  - Push the red emergency stop button in to the "off" position.
  - Press and hold the function activation button switch, and activate each boom and platform function button switch.

Result: no function can be run.

- Turn the red emergency stop button out to the "ON" position.
- 2) Test machine function

- Do not press and hold the function enable button switch. Try to enable each boom and platform function button switch.

Result: All boom and platform functions fail.

- Press and hold the function activation button switch, and activate each boom and platform function button switch.

Result: all the functions of boom and platform run for a full cycle. The buzzer sounds when the main boom is descending.

- 3) Test the emergency power unit



**CAUTION: To save battery power, please test each function in half of a cycle.**

- Turn the key switch to the ground control position and turn the red emergency stop button to the ON position.
- Turn the emergency power unit switch and activate each boom function switch at the same time.

Result: all the boom functions shall be operational.

- 4) Automatic leveling of test operation platform

- Press and hold the function enable switch and adjust the operation platform to the horizontal position with the platform leveling button.
- Raising and lowering the boom through a full cycle.

Result: the job platform is always horizontal.

## 8.3 On the Platform

- 1) Test emergency shutdown
  - Turn the key switch to the PCU.
  - Turn the red "Emergency Stop" button out to the "On" position.
  - Push the platform red "Emergency Shutdown" button to the "OFF" position.

Result: all functions are not running.

- Turn the platform red "Emergency Stop"

button out to the "On" position.

2) Test horn

- Press the horn button.

Result: the horn sounds.

3) Testing foot switch

- Do not step on the foot switch before testing the movements of the machine.

Result: no actions run.

4) Test machine function

- Stepping on the foot switch.
- Activate each function control handle or button switch of the machine.

Result: All boom/platform actions work normally within one complete cycle.

5) Test steering (front wheel steering)

- The machine is in the stowed state.
- Stepping on the foot switch.
- Press the left side of the thumb rocker switch at the top of the drive control handle.

Result: the front wheel rotates in the direction indicated by the blue arrow on the drive chassis, the rear wheels depend on the steering mode.

- Press the right side of the thumb rocker switch on the top of the drive control handle.

Result: the front wheel rotates in the direction indicated by the yellow arrow on the drive chassis, the rear wheels depend on the steering mode.

6) Test drive and brake functions

- The machine is in the stowed state.
- Stepping on the foot switch.
- Slowly move the drive control handle in the direction indicated by the blue arrow on the control panel until the machine starts to move, and then restore the handle to the center position.

Result: The machine should move in the direction indicated by the blue arrow on the drive chassis and then stop suddenly.

- Slowly move the drive control handle in the direction indicated by the yellow arrow on the control panel until the machine starts to move, and then restore the handle to the center position.

Result: the machine should move in the direction indicated by the yellow arrow on the drive chassis and then stop suddenly.



**CAUTION: The brake must be able to stop the machine on any slope it can climb on.**

7) Test tilt sensor

- Stepping on the foot switch.
- Raise the boom 5° or extend it 0.6 m, and drive the machine to a slope inclining 5° in the boom direction.

Result: The machine tilt indicator lamp is on, the buzzer sounds, and some actions are restricted.

- Raise the boom 5° or extend it 0.6 m, and drive the machine to a slope inclining 5° in the direction orthogonal to the boom.

Result: The machine tilt indicator lamp is on, the buzzer sounds, and some actions are restricted.

- Drive the machine up to the slope of the maximum allowable tilt angle of the chassis.
- Start all boom functions successively.
- Operate the handle to activate the rotary table slewing function.

Result: The boom cannot be raised upward after it is raised upward to the position 5° above the horizontal level; The boom cannot continue to extend after being extended by 0.6 m, and the functions such as boom extension, boom luffing up, rotary table slewing, leveling, steering, and walking are limited. Other boom functions can be used normally.



**CAUTION: If the rotary table inclines 5° in the boom direction or 5° in the direction vertical to the boom (the maximum allowable inclination angle of the chassis), the boom can be raised more than 5° above the**

**horizontal plane or extended more than 0.6 m, and the machine should be marked immediately and stopped.**

8) Test floating cylinder

- The machine is in the stowed state.
- Stepping on the foot switch.
- Drive the right steering wheel to a 10 cm high barrier or curb.

Result: The remaining three tires are in close contact with the ground.

- Drive the left steering wheel to a 10 cm high barrier or curb.

Result: The remaining three tires are in close contact with the ground.

- Drive the left rear wheel to a 10 cm high obstacle or curb.

Result: The remaining three tires are in close contact with the ground.

- Drive the right rear wheel to a 10 cm high obstacle or curb.

Result: The remaining three tires are in close contact with the ground.

9) Test drive enable system

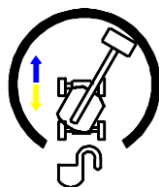

Figure 8-1 Drive Enable

- The machine is in the stowed state.
- Stepping on the foot switch.
- Turn the rotary table until the boom is at a certain angle, as shown in Figure 8-1.

Result: At any position of the boom within the range shown in the figure, the drive enable indicator lamp should be flash.

- Move the drive control lever away from the center position.

Result: the drive function does not work.

- Turn the drive enable button switch to the upper side and release it, and meanwhile

slowly move the drive control lever away from the center position.

Result: The drive function runs.

**CAUTION:** When using the drive enable system, the machine may travel in the opposite direction of travel and steering control handle movement. Use the color scale direction arrow on the drive chassis to determine the direction of movement.

10) Test limited drive speed

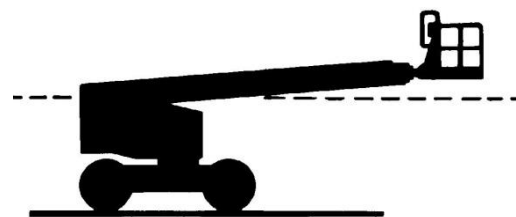

- Stepping on the foot switch.
- Raise the boom 5° (with the boom fully retracted).
- Slowly move the drive control handle to the full drive position.

Result: the maximum drive speed possible does not exceed 0.8 Km/h in the boom lifting state.

- Lower the boom to the retracted state.
- Extend the boom about 0.6 m.
- Slowly move the drive control handle to the full drive position.

Result: the maximum drive speed that the boom can reach in the extended state shall not exceed 0.8 Km/h.

**CAUTION:** If the driving speed of the boom when it is raised or extended exceeds 0.8 Km/h, the machine shall be marked and stopped immediately.

11) Rotary table rotation speed of test limit

- Stepping on the foot switch.
- Lower the boom to the retracted state.
- Extend the boom a certain length. The

length of each model is shown in the following table.

- Slowly move the rotary table control handle to the full drive position.

Result: it takes no less than a certain time for the boom to rotate for one circle in the extended state. The time of each model is shown in the following table.

Model	Length (m)	Time (S)
T20JE	12m	115
T22JE	13.3m	135
T26JE	16.3m	160
T28JE	17.5m	170

Table 8-1



**NOTE: If it takes less than a certain time for the boom to rotate for one circle in the extended state, the machine shall be marked immediately and stopped.**

#### 12) Platform overload test

- Load the platform with heavy objects exceeding the limited load.

Result: the indicator lamp is on, the buzzer sounds, and the machine cannot be operated.

- Remove the load on the platform until the indicator lamp goes out.

Result: the machine can be operated.

#### 13) Test driver/boom function

- Stepping on the foot switch.
- Move the drive control lever out of the center position and activate a boom function handle or button switch.

Result: Boom functions are not work. The machine will move in the direction indicated on the control panel.

## **Chapter 9 Operating Instructions**



## 9.1 Basic Principles

- 1) This machine is a high-altitude working equipment equipped with a working platform on the straight arm mechanism. This machine can be used to load workers and their personal tools to a certain height from the ground, and can also be used to reach a certain working area above the machine or equipment.
- 2) The operating instructions section provides specific instructions for various aspects of machine operation. It is the responsibility of the operator to follow all safety rules and instructions on the Operation Manual.
- 3) It is not safe or even dangerous to use this machine for other purposes except for lifting personnel and their tools and materials to air workplaces.



**WARNING: This machine is**

**strictly prohibited from carrying goods or being used as a crane.**

- 4) Only trained and authorized personnel can operate this machine. If more than one operator uses the same machine at different time period during the same work shift, they must all be qualified operators and comply with all safety regulations and instructions in the operation manual. This means that each new operator should carry out pre-operation inspection, functional test and workplace inspection before using the machine.

## 9.2 Machine Operation

- 1) On the GCU, turn the key switch to the desired position.
- 2) Make sure that the red "emergency stop" buttons of the GCU and PCU are turned to the ON position.

## 9.3 Emergency Shutdown

- 1) Push the red emergency stop button of the ground or platform controller to the OFF position to stop all functions.
- 2) Repair any function that operates when either red emergency stop switch is pushed in.
- 3) Selecting and operating the GCU will interrupt the platform red "emergency stop"

button function.

## 9.4 Emergency Power

- 1) If the primary power source fails, use the emergency power.
- 2) Turn the key switch to the ground control position or the platform control position.
- 3) Pull out the red "Emergency Stop" button to the "On" position.
- 4) Activate the required function while keeping the emergency power unit switch on.
- 5) When using emergency power on the platform, you should step on the foot switch.
- 6) The drive function cannot be used when the emergency power is used.
- 7) The single continuous use time of emergency power shall not exceed 7.5 minutes.

## 9.5 Operation on the Ground

Turn the key switch to the GCU position.

Turn the red "Emergency Stop" button to the "On" position.

- 1) Adjust the platform position
  - Press and hold the function enabling button.
  - Move the appropriate button switch according to the mark on the control panel to adjust the platform to the appropriate position. Driving and steering functions are not available on the ground.

## 9.6 Operation on the Platform

Turn the key switch to the PCU position.

Turn the red emergency stop button on the ground and platform out to the "on" position.

- 1) Adjust the platform position
  - Stepping on the foot switch.
  - Slowly move the appropriate button switch and control handle as marked on the control panel to adjust the platform to the appropriate position.
- 2) Steering

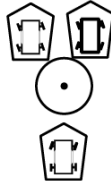

- Select the appropriate steering mode through the steering method selection switch.
- Push down the foot switch and turn the steering wheel by the thumb rocker button at the top of the drive control handle.
- When the button is in the middle, it is in the two wheel steering mode, and only the front wheels is steering. Pull the thumb button to the left, and the front wheel turns in the direction indicated by the blue arrow; Pull the thumb button to the right, and the front wheel turns in the direction indicated by the yellow arrow.
- When the button is turned to the left, it is in the crab steering mode. Pull the thumb button switch and the rear wheel turns in the same direction as the front wheel.
- When the button is turned to the right, it is the four-wheel steering mode. Pull the thumb button switch and the rear wheel turns in the opposite direction to the front wheel.

**! CAUTION: Use the color-coded direction arrows on the PCU and the drive chassis to determine the wheel steering direction.**

### 3) Drive

- Stepping on the foot switch.
- Increase speed: slowly move the drive control handle to make it deviate from the center position.
- Reduce speed: slowly move the drive controller handle so that it points to the center position.
- Stop: Return the drive control lever to the center position or release the foot switch.
- When the boom is raised to a certain angle, the machine movement speed is limited.

**! CAUTION: Use the color-coded direction arrows on the PCU and the drive chassis to determine the machine drive direction.**

### 4) Driving on a slope

- Determine the uphill, downhill and side slope ratings of the machine.

Maximum slope rating:



Platform downhill (climbing ability): 45%(24 °);



Maximum slope rating, platform uphill: 30% (17 degrees);



Maximum side slope rating: 25% (14 °)

**! CAUTION: Slope rating is limited by ground condition and traction. The term climbing capability is only used in platform downhill.**

- Make sure that the boom is located between the rear axle tires, and the boom is lowered below the horizontal plane and retracted. When the rotary table inclines more than 5° along the boom, at this time, the drive function and boom function are not limited.
- When going uphill, move the speed button to the climbing position.

**! CAUTION: when the boom inclines 5° above the horizontal plane, the drive function will be limited. In this case, the boom should be lowered below the horizontal position.**

- Determine the slope

Measure the bevel with a digital inclinometer or follow the steps below for measurement.



- ✓ Tools required: woodworking ruler, straight wood block (the length is at least 1 m), tape measure and other tools.
- ✓ Place the wood block on the bevel, at the end of the downhill, place the woodworking ruler on the upper edge of the wood block, and lift the end of the wood block until it is level.
- ✓ Keep the wood block horizontal and measure the vertical height from the bottom of the wood block to the ground.
- ✓ Height divided by the length of the wood block (stroke), for example:

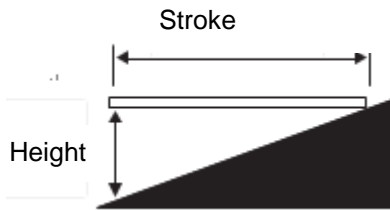

Stroke=3.6 m, raised height=0.3 m

$$0.3 \div 3.6 = 0.083 = 8.3\%$$

**! CAUTION: If the slope exceeds the maximum uphill, downhill or side slope rating, the machine must be lifted or transported up and down along the slope. Please refer to the "Transportation and Lifting" section.**

5) Drive Enable

- The drive enable indicator lamp flashes to indicate that the boom has moved beyond the rear axle tire, the drive is not enabled, and the drive function is limited.
- To drive, pull the drive enable switch upwards and release it, slowly move the drive control handle out of center position.

**! NOTE: That the machine may move in the opposite direction to the drive and steering control handles. To stop the drive, release the handle or foot switch.**

6) Drive motor speed selection



Climbing gear: the low speed mode of the drive motor is selected.

Turtle symbol: the middle speed mode of the drive motor is selected.

Rabbit symbol: drive motor high speed mode is selected.

When driving on an inclined surface or on rough ground, please operate in the low speed range.

7) Differential lock



When the wheels are slipping, the differential lock can be used to lock the differential, thus improving the passability of the vehicle.

The differential lock can be activated and closed only when the vehicle is in a stopped state, or is driven straight at a low speed (equivalent to the speed of a person in walking).

Differential lock enable: toggle and hold the differential lock button. At this time, the differential lock indicator lamp lights up.

Differential lock closed: reset the differential lock button. At this time, the differential lock indicator lamp goes out.

8) Wheel automatic alignment

Turn the wheel automatic alignment button to the left, the wheels will be automatically aligned, and the rear and front wheel alignment indicator lamps will light up, indicating that the wheels have been aligned.

## 9.7 Platform Overload

The platform overload indicator lamp is on and the buzzer alarms, indicating that the platform is overloaded. Remove the load from the platform until the indicator lamp goes out.

## 9.8 Machine Not Level

If the tilt alarm sounds when the platform is lifted (the boom inclines more than 5° above the horizontal plane or the boom extends more than 0.6 m), the Machine not level indicator lamp will come on and the drive function will not be available in both directions. Determine the status of the boom on the slope, which is shown as follows. Before moving the machine to a solid, level ground, follow the steps below to lower the boom. Do not rotate the boom before lowering

it.

If the tilt alarm sounds when the platform goes uphill:

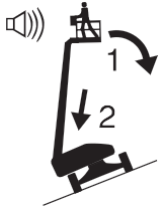

1 Lower the boom.

2 Retract the boom.

If the tilt alarm sounds when the platform goes downhill:

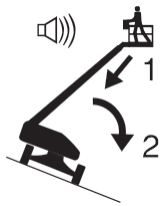

1 Retract the boom.

2 Lower the boom.

## 9.9 Instructions for Red Guard Protective System

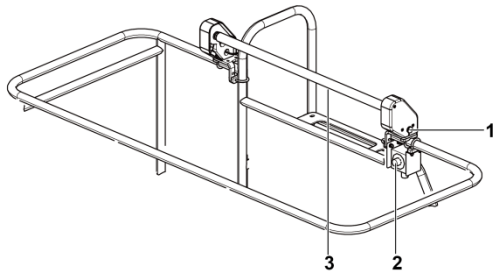

1. Flashing alarm

2. Override switch

Notice: When the entrapment system has been activated, the machine can be operated to a safe position using the override switch.

3. Safety pole

Note: Once the safety rod has slipped or got off track, the safeguard system will be activated. Restore the safety rod at home position will shut down the sound and visual alarm.

- 1) The Red Guard protective system aims to create safe and convenient operating environment for operators on the basis of ensuring operation convenience, the loading capacity of the platform and the operators' field of view.
- 2) The Red Guard protective device is disposed above the control panel of the platform. If the safety pole is stressed, the protective system will be activated instantly, and the device will stop all actions immediately, thereby preventing operators from suffering from secondary injury.
- 3) In the extreme case, the safety pole in the protective device will slip to the bottom to ensure operators have sufficient space for buffering and operation. Upon the activation of the Red Guard protective system, the device will give an alarm prompt tone immediately while the blue alarm light flickers. Through the above two approaches, other site operators are reminded, and the safety awareness of neighboring personnel is improved. In addition, the Red Guard protective system also provides the safety overriding switch for operators, facilitating operators to remove dangers. Benefiting from rigid components of the Red Guard protective system, the reliability of the system is improved greatly, and regular or additional maintenance is reduced.

## 9.10 Battery Charging

### 1) Observing the regulations

1. Charge the battery in a well ventilated place.
2. Charge the battery with the correct AC input voltage indicated on the charger.

3. Only use the battery and the charger approved by the LGMG.

## 2) Lithium battery charging instructions:

1. When charging, check the charging interface of the battery pack to prevent short circuit accidents.
2. Open the battery compartment lid. The compartment lid shall remain open throughout the charging process.

### Charge with charger

#### 1. Pre-select charging power.

##### Through the GCU display

- ① Turn the key button switch to the GCU position.
- ② Turn the red "Emergency Stop" button outward to the ON position.

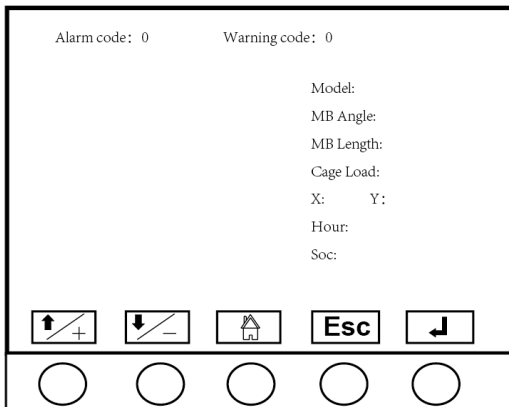

- ③ The system interface is shown in the figure above, and press the "Next Page" button.

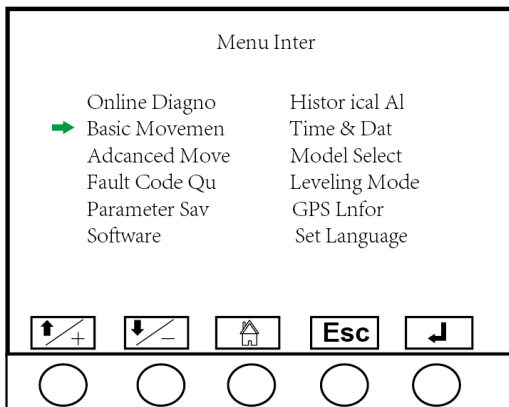

- ④ Select "Basic Movements Settings" and confirm.

- ⑤ Enter the administrator password and confirm. If necessary, contact the LGMG service personnel.

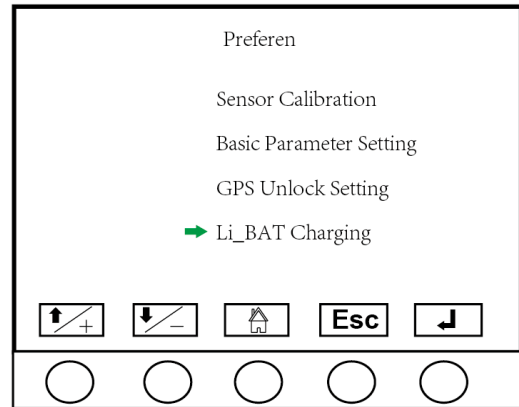

- ⑥ Select "Lithium Battery Charging Settings" and confirm.

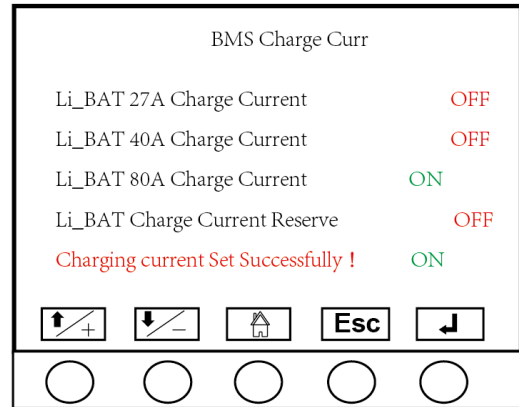

- ⑦ Select the appropriate charging current and confirm it according to the site conditions. As shown in the figure above: select Li-BAT 80 A charging current and confirm. At this time, Li-BAT 80 A charging current shows "ON" on the right and "Charging current gear is set successfully, charging is available!" at the bottom. , ON".

When the field distribution box (circuit breakers of 32A and above Spec., sockets of 32 A and cables of at least 4 mm<sup>2</sup>) meets the requirements, the vehicle can be charged with full power output; The 80A charging current range can be pre-selected via the display screen of GCU. If the above requirements are not met, if there is a 16A or 10A socket on site, the 40A or 27A charging current range can be selected respectively through the

display screen. If the requirements are not met, do not change the charging structure without permission. Please contact the after-sales service personnel of the manufacturer or the service personnel of the leasing company on how to use the configurable charging scheme.

- ⑧ Turn the red "Emergency Stop" button inward to the off position.
- 2. Connect the battery charger to the grounded AC circuit.
- 3. Please pay attention to the indicator lamp information when charging the battery, the indicator lamp flashes during charging, and the indicator lamp on the charger is always on when fully charged, please disconnect the charger and the battery pack after charging.

Charging state	Charging indicator lamp display
<50%	Orange LED light slowly flashing
50%~75%	Orange LED light quick flashing
75%~99%	Green LED light quick flashing
100%	Green LED light comes on normally
Voltage-stabilized power supply failure	Red LED light flashing

**Charging with a charging pile (If equipped):**

- 1. Check whether the charging pile is normal: it mainly includes the charging pile body, charger and charging cable.
- 2. Check whether the charging socket of the vehicle is normal: it mainly includes whether there are sundries, wear, etc. at the socket.
- 3. Hold the charger in one hand and the cable in the other hand. Press the button at the charger tip with your thumb, and keep the charger at the same level as the charging socket. When the charger is inserted into the charging socket, you can hear a click, indicating that the charger is inserted in

place.

- 4. After the charging pile automatically stops charging, you should hold the charger handle firmly with the right hand, press the unlocking button with the thumb, hold the lower end of the charger body with the left hand, and pull out the charger vertically with uniform force.
- 5. After the charger is pulled out from the vehicle charging socket, insert the charger into the charger holder of the charging pile in the same way as charging.
- 6. Cover the vehicle charging port, close the charging pile door and lock it.



**Danger: When inserting the charger, make sure it is coaxial and press the button. It is strictly forbidden to insert the charger obliquely, to touch the charger tip by hand, or to place the charger at will. It is forbidden to pull the charger during the charging process. When the charger is being pulled out, arc will occur between the charger and the charger tip, which will damage the components and may hurt people in serious cases.**

**3) Discharge instructions for lithium batteries:**

- 1. Turn on the battery pack only when discharging.
- 2. A fully charged battery pack needs to be restarted before it can be discharged.
- 3. Please use the original matching connectors to connect vehicles or electrical appliances, and please keep the discharge interface clean, dry and stable.
- 4. The battery pack is designed for special vehicles and shall not be replaced at will.
- 5. Please deactivate the battery pack immediately when the battery pack buzzer warning in the use of vehicle, and charge it in time when the SOC value is low.
- 6. In order to ensure the service life of battery pack, do not discharge excessively.
- 7. The battery shall be prevented from short circuit or overcurrent during discharging.

#### 4) Safety Notices

1. Requirements for external ambient temperature of battery system:  $-30^{\circ}\text{C} \sim 50^{\circ}\text{C}$ .
2. The temperature difference of the external working environment of the battery system:  $\leq 5^{\circ}\text{C}$ .
3. Humidity requirements for the external working environment of the battery system:  $10\% \leq \text{humidity} \leq 90\% \text{RH}$ .
4. During the use of the battery system, it shall try to keep the SOC above 30% to avoid overcharging and overdischarging.
5. When the battery system is not in use for a short period of time, it is required to keep the SOC above 60%, and store it in a dry and well-ventilated warehouse at  $0^{\circ}\text{C} \sim 35^{\circ}\text{C}$ . It is forbidden to put it in a place where is easy to get wet, exposed to the sun or soaked in water. Tests for charge and discharge shall be conducted at least once every month, so as the monitoring of battery status. Including total pressure, temperature, pressure difference, temperature difference, insulation resistance, SOC, etc. If any problems are found, the service personnel shall be notified in time for troubleshooting.
6. It shall not be placed upside down or lying down during the storage or using.

#### 5) Emergency operation

Under the personal safety ensuring condition, perform the following operations conditionally:

1. Set a working area not less than 1m, and prohibit irrelevant vehicles and personnel from entering.
2. If the wire harness smokes and catches fire, wear personal protective equipment to spray the ignition point with dry powder fire extinguisher and carbon dioxide fire extinguisher.
3. If there is a fire during the charging process, be sure to turn off the power supply of the charging station immediately before the next step of fire extinguishing operation.

4. If the personnel inhales thick smoke accidentally, please transfer them and seek for medical attention as soon as possible. Call the police according to the scene.

### 9.11 Description of the panel bracket

#### Installation instructions

Before operating the machine, ensure that:

- You have read and understood, and will follow the safety rules and operating instructions.
- The panel bracket will be installed by authorized personnel.
- Immediately mark and stop using the damaged or malfunctioning machines.
- Any damaged or malfunctioning machine has been repaired before operating the machine.
- All necessary tools and parts are ready and available.
- You have read the process completely and will follow the instructions. Trying shortcuts can bring dangers.

#### Basic Principles

- Read, understood, and follow all warnings and instructions.



#### Risk of physical injury

- Failure to follow the instructions and safety rules when using the LGMG panel brackets can result in serious injury.
- Do not exceed the rated platform load. The total weight of the bracket, panel, operator, tools and other equipment shall not exceed



the rated load.

- Total weight of the panel bracket: 18 kg.
- Maximum load of the panel bracket: 113 kg.
- Use straps to secure the panel to the platform beam.
- Do not lift the panel without being informed of or understanding the dangers associated.
- When lifting or lowering a fixed or pendulous load, do not produce a vertical or lateral force on the machine.
- Maximum panel height: 1.2 m.
- Maximum allowable air velocity of the panel: 12.5 m/s.
- Maximum panel area: 3 m<sup>2</sup>.

### Installation of the panel bracket

Note: Park the machine on a solid and flat surface, and lower the boom to the folded state.

- 1) Adjust the platform so that the platform bottom plate is at an appropriate height.

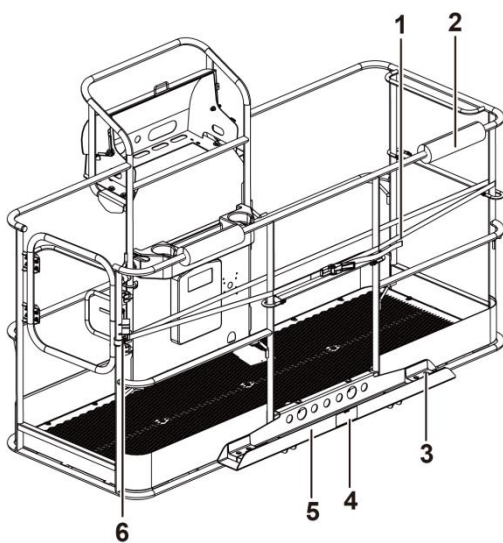

Figure 9-1

1. Strap

2. Sponge sheath
3. Rubber mat
4. Logo
5. Panel bracket
6. Pipe clamp

- 2) Place the upper part of the panel bracket in front of the bottom plate of the platform and press the bracket downward until it is flush with the upper surface of the bottom plate and the slot of the bracket is aligned with the corresponding slot on the bottom plate of the platform, as shown in Figure 9-1.

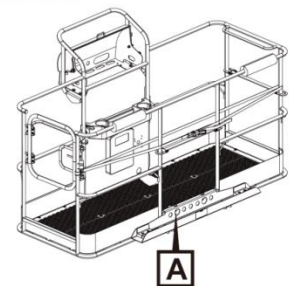
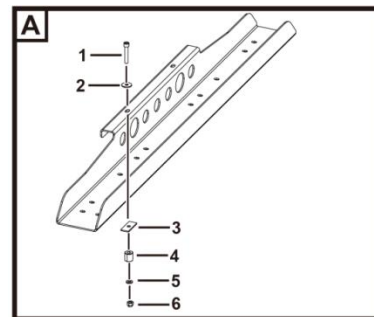

Figure 9-2

1. Bolt
2. Washer
3. Subplate
4. Shaft sleeve
5. Washer
6. Nut

- 3) Preinstall the bolts, subplates, shaft sleeve, washers and nuts without tightening them first, as shown in Figure 9-2.

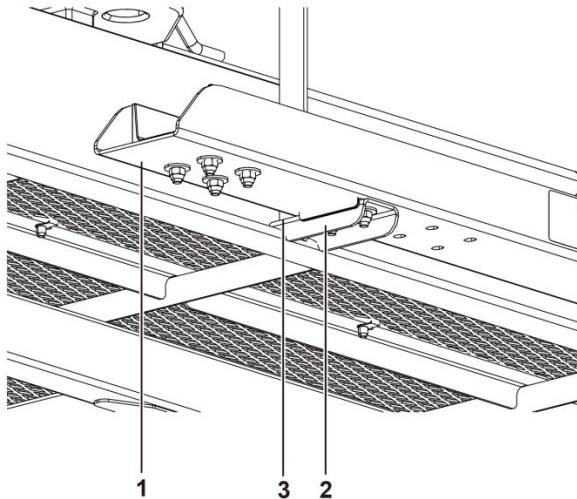

Figure 9-3

1. Bottom of the panel bracket
2. Support
3. Adjusting shim
- 4) Fix the panel support to the bottom of the panel bracket, with the front and bottom of the support in contact with the round tube of the platform, as shown in Figure 9-3.
- 5) Tighten the fasteners on the upper panel bracket.
- 6) Adjust the gap between the panel bracket and the support using the adjusting gaskets, and tighten them with fasteners, as shown in Figure 9-3.
- 7) Install the rubber pad into the groove of the panel bracket and secure it with fasteners, as shown in Figure 9-1.
- 8) Install the sponge sheath onto the top bar of the platform, as shown in Figure 9-1.
- 9) Attach the strap and pipe clamp to the vertical beam of the platform. Attach the strap to the pipe clamp, and tighten it with fasteners until the pipe clamp is fixed but is

still able to slide freely on the vertical beam, as shown in Figure 9-1.

#### Instructions

- 1) Secure the panel bracket and strap to the platform.
- 2) Place the load at the center of the platform.
- 3) Use a strap to secure the load to the platform.
- 4) Tighten the strap.

## 9.12 System Failure

The buzzer alarms and the system fault indicator lamp illuminates to indicate a control system fault. The LCD screen will display the corresponding fault code, and the machine will turn off the corresponding function, as shown in Table 9-1.

When the system indicator lamp is on, please follow these steps:

- 1) Lower and indent the boom.
- 2) Move the machine to the storage position, mark the machine and stop using it.
- 3) Personnel with relevant qualifications shall carry out maintenance, remove the fault and conduct a comprehensive inspection before re-use.

4) The system fault code is shown in the following table:

Fault code	Fault description	Limit action
1	Controller output power supply 1 open circuit	Boom luffing up
2	Controller output power supply 2 open circuit	Boom luffing up
3	Controller output power supply 3, 4 open circuit	Boom luffing up
4	The CAN bus of the platform electric box expansion module is disconnected	Equivalent to the failure of all three handles
5	The display bus of chassis electric box is disconnected	No data on display
7	Rotary table tilt sensor failure	Boom luffing up, boom luffing down, boom extension, boom retraction, rotary table slewing, walking
8	Load cell 1 fault	Boom luffing up
9	Load cell 2 fault	Boom luffing up
10	Load cell 3 fault	Boom luffing up
11	Load cell 4 fault	Boom luffing up
12	Left handle fault	Boom luffing up, boom luffing down (superstructure operation), rotary table slewing (superstructure operation)
13	Right handle fault	Boom luffing up, walking, steering
14	Middle handle fault	Boom luffing up, boom extension, boom retraction (superstructure operation)
15	Wire rope fault	Boom luffing up, boom luffing down, boom extension, boom retraction, rotary table slewing, walking
16	Boom angle sensor 1 fault	Boom luffing up
17	Boom angle sensor 2 fault	Boom luffing up
18	Boom angle sensor verification fault	Boom luffing up
19	Boom length sensor 1 fault	Boom luffing up, boom extension
20	Boom length sensor 2 faulty	Boom luffing up, boom extension
21	Boom length sensor verification fault	Boom luffing up, boom extension
22	Load cell calibration failure	Boom luffing up
23	Main boom retraction approach switch 1 failure	Main boom upper luffing
24	Main boom retraction approach switch 2 failure	Main boom upper luffing
25	Main boom extension approach switch 3 failure	Main boom upper luffing



26	Main boom extension approach switch 4 failure	Main boom upper luffing
28	Drive motor driver failure	Unable to walk
29	Drive motor driver bus disconnected	Unable to walk
30	Pump motor driver failure	No movement except walking
31	Pump motor driver bus disconnected	No movement except walking
32	BMS bus disconnected	The whole machine has no action.
33	BMS failure	The whole machine has no action.
34	Travel overspeed	Forward/backward, left/right steering
35	Leveling sensor verification fault	Boom luffing up/down
36	Leveling sensor communication fault	Boom luffing up/down
101	Boom luffing up at maximum angle limited	Boom luffing up
102	Boom luffing down at minimum angle limited	Boom luffing down
103	Boom extension at maximum length limited	Boom extension
104	Boom retraction at minimum length limited	Boom retraction
105	Chassis tilted	-
106	Rotary table tilted, boom angle greater than 5°, boom luffing up and boom extension limited	Boom luffing up, boom extension, rotary table slewing, walking
107	Rotary table tilted, boom extension more than 60 cm, boom luffing up and boom extension limited	Boom luffing up, boom extension, rotary table slewing, walking
109	Travel function limit not enabled in drive	Walking
110	Platform overload	Limit all actions
111	Length & angle sensor bus disconnected	Boom luffing up, boom extension
112	Length & angle sensor failure	Boom luffing up, boom extension
114	The operation range exceeds the limit of the safe area.	Boom luffing down, boom extension
115	Manual car lock reminder	Boom luffing up, boom extension
116	Manual car lock	Boom luffing up, boom extension, walking
117	GPS and ECU do not match	Not used
118	GPS removed	Boom luffing up, boom extension
119	The platform load is less than 100Kg	Boom luffing down, boom extension, boom retraction, rotary table slewing, fly jib luffing, platform leveling
120	Operation sequence warning	-
121	Enable Timeout	-
122	Wrong selection of superstructure and chassis	-

123	Travel motor Warning	-
124	Pump motor warning	-
125	Voltage low	

Table 9-1 System Fault Codes and Limiting Actions

## 9.13 After Each Use

- 1) Select a solid horizontal safe parking position in a moisture-proof, high temperature-resistant, open flame-proof, corrosive gas free and well-ventilated place.
- 2) Retract and lower the boom to the stowed state.
- 3) Close and lock all hoods and doors.
- 4) Wipe off dust and oil stains on the body and keep the body clean.
- 5) Turn the rotary table so that the boom is between the rear axle wheels.
- 6) Fix the wheel with plug block.
- 7) Turn the key button switch to the "OFF" position and remove the key to avoid unauthorized use.
- 8) Charge the battery (if necessary).
- 9) Long-term storage
  - Disconnect the main power switch, and clean and maintain the whole machine before use.
  - When the storage period exceeds three months, it shall be operated once a month for not less than one hour each time, and cleaning and maintenance shall be carried out.

## **Chapter 10 Transportation Instructions**



## 10.1 Observing the Regulations

- 1) The driver shall be responsible for ensuring that the machine is properly fixed and that the appropriate trailer is selected in accordance with local traffic regulations.
- 2) Only the personnel qualified for lifting operation at heights can lift the machine.
- 3) The transport trailer must be parked on level ground.
- 4) When loading the machine, the transport vehicle must be secured to prevent movement.
- 5) Make sure that the vehicle load, loading surface, chains or belts, etc. are sufficient to support the weight of the machine. Please refer to the "nameplate" for the weight of the machine.

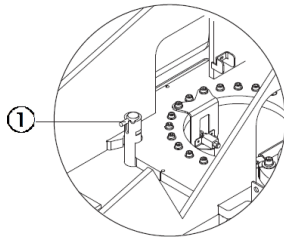

Figure 10-1 Rotary table rotating lock pin

- 6) Ensure that the rotary table is secured with the rotary table rotary lock before transport, as shown in Figure 10-1. Ensure that the rotary table is unlocked during operation.
- 7) Do not drive the machine on a slope that exceeds the machine's uphill, downhill or slope rating. Refer to "driving on slopes" in the "operating instructions" section.
- 8) If the grade of the transport vehicle exceeds the maximum slope rating, a winch must be used to load and unload the machine according to the brake release instructions.
- 9) The platform is equipped with a precise weighing system. It is forbidden to place heavy objects on the platform during vehicle transportation, otherwise the weighing system may be damaged.

## 10.2 Brake Release

- 1) Block the wheel with a wedge to prevent the machine from moving.

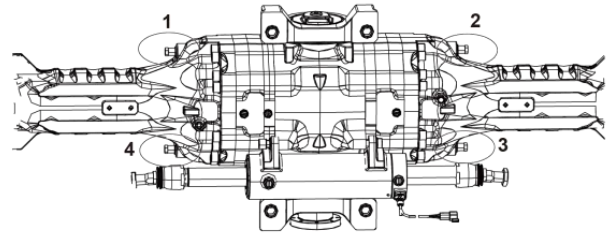

Figure 10-2 Brake Release

- 2) Unscrew the four brake release screws of the rear axle inwards, as shown in Figure 10-2.
- 3) Act on front axle in the same way.
- 4) It must be ensured that the winch cable is properly secured to the fastening point of the drive chassis and there are no obstructions on the channel.
- 5) Perform the above procedure in reverse order to re-engage the brake.

## 10.3 Ensuring Transportation Safety

- 1) The rotary table should be locked with a turntable rotating locking pin each time the machine is transported, as shown in Figure 10-1.
- 2) Before transportation, turn the key switch to the "off" position and remove the key.
- 3) Inspect the machine thoroughly to prevent loose or unsecured parts.
- 4) Fixed chassis:

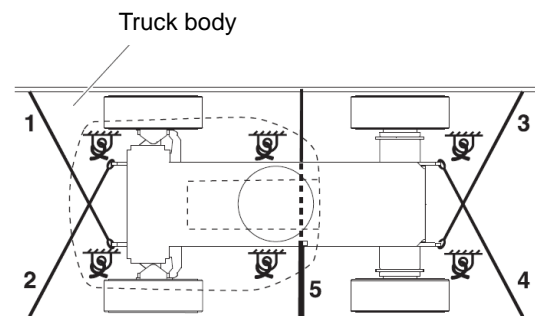

Figure 10-3 Schematic diagram of fixed chassis

Ensure that the chain or belt has sufficient load strength and use at least 5 chains. Adjust the rigging to prevent damage to the chain, as shown in Figure 10-3.

- 5) Fixed platform:

Method 1:

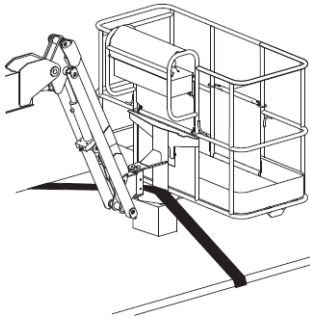

Figure 10-4 Schematic diagram of the fixed platform

Place the cushion block under the rotating connection of the platform and keep it away from the platform cylinder. Pass the nylon strap through the platform support to secure the platform. Do not apply excessive downward force when protecting boom components, as shown in Figure 10-4.

Method 2:

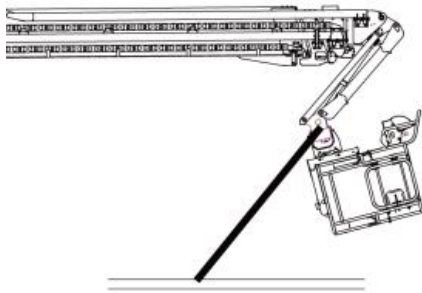

Figure 10-5 Schematic Diagram of Fixed Platform

- Operate with GCU.
- Lower the jib boom to the stowed position.
- Lower the platform as much as possible so that the platform is under the boom.
- Pass the nylon strap through the platform support to secure the platform.
- Do not apply excessive downward force when protecting boom components.

## 10.4 Guidance for Lifting

- 1) Only qualified lifting and rigging assemblers can assemble rigging and lifting the machine.
- 2) Ensure that the lifting capacity of the crane and the belts or ropes is sufficient to

support the weight of the machine. Please refer to the "nameplate" for the weight of the machine.

- 3) Before hoisting, use the GCU to raise the jib boom to the horizontal position to prevent the platform from touching the ground during hoisting and causing deformation of the boom. The rest of the booms are completely lowered and retracted, removing all the moving parts and items on the machine.
- 4) Secure the turntable using the turntable rotary lock.
- 5) The rigging can only be attached to the designated lifting point on the machine.
- 6) Adjust the rigging to avoid damage to the machine and keep the machine level.

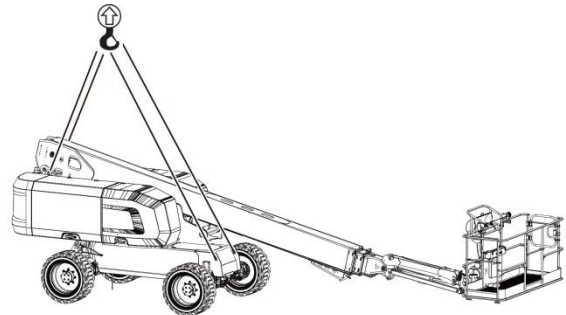

Figure 10-6 Lifting point (take T20JE as an example)

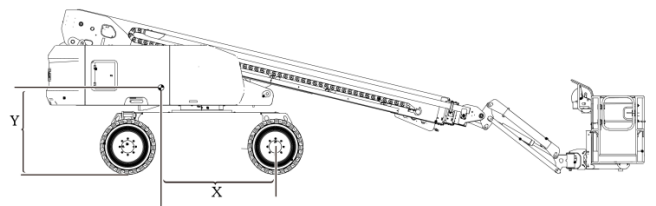

Figure 10-7 Center-of-gravity position of the machine

Type	X-axis (mm)	Y-axis (mm)
T20JE	1760	1320
T22JE	1700	1290
T26JE	1890	1380
T28JE	1880	1370

Table 10-1

