



# Operation Manual

---

---

**AR16J**

## **Mobile Elevating Work Platform**

### **Warning**

Before operation and maintenance, the drivers and service personnel shall always read and thoroughly understand all information in this manual. Failure to do so may result in, fatal accidents or personal injury.

This manual must be kept with this machine at all times.

# Mobile Elevating Work Platform Operation Manual

880\*1230 mm 16 format 8 printed sheets

First edition and printed for the first time in December 2021

---

**Lingong Group Jinan Heavy Machinery Co., Ltd.**

Add: 12th Floor, Building 3, Lushanguoaocheng, 9777 Jingshi Road, Lixia District, Jinan, China

Tel: 86-0531-67605017

Fax: 86-0531-67605017

Technical service: 86-0531-67605017

Web: [www.LGMG.com.cn](http://www.LGMG.com.cn)

Accessories sales: 86-0531-67605016

# Contents

|   |     |
|---|-----|
| Foreword.....                           | III |
| Safety Precautions .....                | IV  |
| Chapter 1 Safety .....                  | 1   |
| 1.1 Danger.....                         | 3   |
| 1.2 No Operation Is Allowed Unless..... | 3   |
| 1.3 Classification of Hazards .....     | 3   |
| 1.4 Intended Purpose .....              | 3   |
| 1.5 Safety Sign Maintenance .....       | 3   |
| 1.6 Risk of Electric Shock .....        | 4   |
| 1.7 Risk of Tipping .....               | 4   |
| 1.8 Safety in the Work Area .....       | 4   |
| 1.9 Risk of Crushing .....              | 6   |
| 1.10 Risk of Operating on Slopes .....  | 6   |
| 1.11 Risk of Falling .....              | 6   |
| 1.12 Risk of Collision .....            | 6   |
| 1.13 Risk of Component Damage.....      | 7   |
| 1.14 Risk of Explosion and Fire .....   | 7   |
| 1.15 Risk of Machine Damage.....        | 7   |
| 1.16 Risk of Bodily Injury .....        | 7   |
| 1.17 Battery Safety .....               | 7   |
| 1.18 Locked After Each Use .....        | 8   |
| 1.19 Check Tires and Wheels .....       | 8   |
| Chapter 2 Legend .....                  | 9   |
| Chapter 3 Decals .....                  | 13  |
| Chapter 4 Specification .....           | 21  |
| Chapter 5 Control Unit.....             | 27  |
| 5.1 Lower Control Box .....             | 29  |
| 5.2 Upper Control Box .....             | 32  |
| Chapter 6 Pre-Operation Inspection..... | 35  |
| 6.1 No Operation Is Allowed Unless..... | 37  |
| 6.2 Basic Principles .....              | 37  |
| 6.3 Pre-Operation Inspection .....      | 37  |
| Chapter 7 Workplace Inspection .....    | 39  |
| 7.1 No Operation Is Allowed Unless..... | 41  |
| 7.2 Basic Principles .....              | 41  |
| 7.3 Workplace Inspection.....           | 41  |

|  |    |
|--|----|
| Chapter 8 Functional Test .....                              | 43 |
| 8.1 No Operation Is Allowed Unless.....                      | 45 |
| 8.2 Basic Principles .....                                   | 45 |
| 8.3 Functional Test.....                                     | 45 |
| 8.4 Tests from the Lower Control Box .....                   | 45 |
| 8.5 Tests from the Upper Control Box .....                   | 46 |
| Chapter 9 Operating Instructions.....                        | 49 |
| 9.1 No Operation is Allowed Unless.....                      | 51 |
| 9.2 Basic Principles .....                                   | 51 |
| 9.3 Starting the Engine .....                                | 51 |
| 9.4 Emergency Stop .....                                     | 51 |
| 9.5 Auxiliary Power .....                                    | 52 |
| 9.6 Operation from the Ground Control Station.....           | 52 |
| 9.7 Operation from the Platform Control Station .....        | 52 |
| 9.8 Platform overload.....                                   | 54 |
| 9.9 Tilt Indicator .....                                     | 54 |
| 9.10 System Fault.....                                       | 54 |
| 9.11 Parking and Storage .....                               | 56 |
| 9.12 Instructions for skyguard.....                          | 56 |
| 9.13 Fall protection .....                                   | 56 |
| 9.14 Machine Safety System Override(MSSO)(If equipped) ..... | 56 |
| Chapter 10 Instructions for Transportation and Lifting ..... | 57 |
| 10.1 Compliance.....   | 59 |
| 10.2 Freewheel configuration for trailers.....               | 59 |
| 10.3 Transportation Safety.....                              | 59 |
| 10.4 Lifting instructions .....                              | 60 |

## Foreword

Thank you for choosing to use this Mobile Elevating Work Platform from LGMG. This machine is designed according to AS/NZS 1418.10:2011+A1:2017. The information specified in this manual is intended for the safe and proper operation of this machine for its' intended purpose.

For maximum performance and utilization of this machine, thoroughly read and understand all the information in this manual before starting, operating, or performing maintenance on this machine.

Due to continuous product improvements, LGMG reserves the right to make specification changes without any prior notifications. For any updated information, contact LGMG.

Ensure all preventive maintenance to the machine is performed according to the interval specified in the maintenance schedule.

Keep this manual with this machine for reference at all times. When the ownership of this machine is transferred, this manual shall be transferred with this machine. This manual must be replaced immediately if it is lost, damaged, or becomes illegible.

This manual is copyrighted material. The reproduction or copy of this manual is not allowed without the written approval of LGMG.

The information, technical specifications and drawings in this manual are the latest available when this manual is issued. Due to continuous improvement, LGMG reserves the right to change the technical specifications and machine design without notice. If any specifications and information in the manual are not consistent with your machine, contact the service department of LGMG

### **WARNING**

**Only personnel who have been properly trained and qualified to operate or maintain this machine can operate, repair and maintain this machine.**

**Improper operation, maintenance, and repair are dangerous and can cause personal injury and death.**

**Before any operation or maintenance, the operator shall thoroughly read this manual. Do not operate, perform any maintenance or make any repairs on this machine before reading and understanding this manual.**

**The user shall load the platform strictly according to the load rating of the platform. Do not overload the platform or make any modifications to the platform without permission from LGMG.**

**The operation regulations and preventions in this manual are only applicable for the specified use of this machine.**

# Safety Precautions

The operator of this machine shall understand and follow the existing safety regulations of state and local governments. If these are unavailable, the safety instructions in this manual shall be followed.

To help prevent accidents, read and understand all warnings and precautions in this manual before operation or performing maintenance.

The safety measures are specified in Chapter 1 Safety.

It is impossible to foresee every possible hazard and the safety instructions in this manual may not cover all safety prevention measures. Always ensure the safety of all personnel and protect the machine against any damage. If unable to confirm the safety of some operations, contact LGMG.

The operation & maintenance prevention measures listed in this manual are only applicable to the specified uses of this machine. LGMG assumes no responsibility if this machine is used beyond the range of this manual. The user and the operator shall be responsible for the safety of such operations.

Do not perform any operation forbidden in this manual in any situation.

The following signal words are applicable for identifying the level of safety information in this manual.

 **Danger:**

**An imminent situation, that if not avoided, will result in severe injuries or death. This is also applicable to situations that will cause serious machine damage, if not avoided.**

 **Warning:**

**A potentially dangerous situation, that if not avoided, may result in severe injuries or death. This is also applicable to situations that may cause serious machine damage, if not avoided.**

 **Notice:**

**A situation, that if not avoided, may result in minor or intermediate injury. This is also applicable to situations that may cause machine damage or shorten machine service life.**

# Chapter 1 Safety





## 1.1 Danger

Failure to follow the instructions and safety rules in this manual may cause death or serious injury.

## 1.2 No Operation Is Allowed Unless

You have understood and practiced the rules for safe operation of the vehicle in this manual.

- 1) Avoid dangerous situations. Know and understand the safety rules before proceeding with the next step.
- 2) Always perform a pre-operation inspection.
- 3) Always perform a pre-use functional test.
- 4) Check the workplace.
- 5) Use the vehicle only for its intended purpose.
- 6) Read, understand, and follow the manufacturer's instructions and safety rules - safe operation manuals and vehicle labels.
- 7) Read, understand and follow user safety rules and work site regulations.
- 8) Read, understand and follow all applicable government laws and regulations.
- 9) You have received the training on safe operation of the vehicle.

## 1.3 Classification of Hazards



### Classification of hazards

The meanings of symbols, color codes and characters of LGMG's products are as follows:

**Security warning symbol:** are used for warning of potential personal injuries. Observe all safety instructions below these signs, to avoid situations causing potential personal injury and death.



**Red:** Signifies dangerous situations. If not avoided, will result in personal death or severe injury.



**Orange:** Signifies dangerous situations. If not avoided, may result in personal death or severe injury.



**Yellow:** Signifies dangerous situations. If not avoided, may result in minor or intermediate personal injury.

Notice

**Blue:** Signifies dangerous situations. If not avoided, property loss or damage can occur.

## 1.4 Intended Purpose

This vehicle is only used to lift operators and their tools and materials to high-altitude workplaces.



It is strictly forbidden to use the machine to carry loads.

## 1.5 Safety Sign Maintenance

- 1) The operators should always keep in mind

their safety when replacing any missing or damaged safety signs.

- 2) The safety decal should be cleaned with mild soap and water.
- 3) Do not use solvent-based cleaners as they may damage the material of the safety label.

### 1.6 Risk of Electric Shock

- 1) This machine is not insulated and is not provided with electrical shock protection when it comes into contact with or near electrical wire.

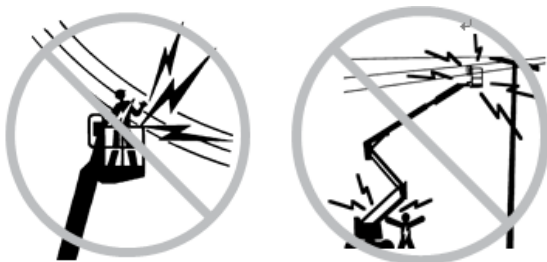

- 2) This machine should be kept an adequate safety distance from power line and electrical equipment according to applicable government laws and regulations and the following table.

| Voltage      | Required safety distance |
|--------------|--------------------------|
| 0~50KV       | 3.05m                    |
| 50KV~200KV   | 4.6m                     |
| 200KV~350KV  | 6.1m                     |
| 350KV~500KV  | 7.62m                    |
| 500KV~750KV  | 10.67m                   |
| 750KV~1000KV | 13.72m                   |

- 3) The effects of strong winds or gusts on the movement of the platform, the swinging and slackening of the wires should be considered.
- 4) If the machine comes into contact with live wires, keep away from the vehicle. No one is allowed to touch or operate the vehicle on the ground or platform before cutting off the power supply.

- 5) Do not operate the machine when there is lightning or storms.
- 6) Do not use the machine as a ground wire when welding.

### 1.7 Risk of Tipping

The personnel, equipment and materials on the platform may not exceed the maximum load capacity of the platform.

| Maximum load                  | AR16J    |
|-------------------------------|----------|
| Maximum number of people      | 2 people |
| Maximum allowable wind speed  | 12.5m/s  |
| Maximum platform working load | 230kg    |

### 1.8 Safety in the Work Area

- 1) The boom can be lifted or extended only when the vehicle is on a solid, flat surface.

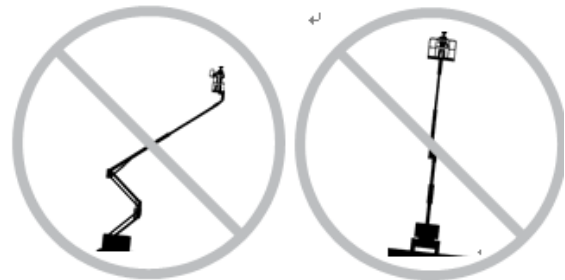

- 2) When the platform is lifted, drive speed may not exceed 0.8km/h
- 3) The tilt sensor may not be used as a level indicator. The alarm on the turntable will sound only when the vehicle is heavily tilted.
- 4) When the alarm sounds: Do not extend, rotate or lift the boom beyond the horizontal plane. The vehicle should be moved to a solid, flat surface before lifting the platform. If the alarm sounds when lifting the platform, the boom should be telescoped carefully and the platform should be lowered. Do not rotate the boom during lowering. The vehicle should be moved to a solid, flat surface before lifting the platform.
- 5) For outdoor operation, do not lift the boom when the wind speed may exceed 12.5 m/s.

If the wind speed exceeds 12.5 m/s after the boom is lifted, the boom should be lowered and do not continue to operate the vehicle.

- 6) Do not operate the vehicle in strong winds or gusts. Do not increase the surface area of the platform or load. Increasing the area exposed to the wind will reduce the stability of the vehicle.
- 7) Do not operate the vehicle with the upper control box when the platform is caught, jammed, or other nearby objects are blocking its normal movement. If you want to operate the vehicle with the lower control box, you must operate it after all personnel have left the platform.
- 8) In the telescoped state, the vehicle should be operated carefully and slow down when driving on uneven terrain, gravel, unstable or smooth surfaces, near holes or steep slopes.



- 9) When the boom is lifted or extended, the vehicle may not drive on uneven terrain, unstable surfaces, or other dangerous conditions, or near these areas.
- 10) Do not push or pull any object that is outside the platform.
- 11) Do not use the vehicle as a crane.
- 12) Do not place, tie, or hang any loads on any part of the vehicle.



- 13) Do not use the boom to push the vehicle or other object.

- 14) Do not make the boom contact adjacent components.
- 15) The limit button switch may not be changed or disabled.
- 16) The boom or platform may not be tied to adjacent components.
- 17) The load may not be placed outside the perimeter of the platform.
- 18) Do not modify the elevating work platform without the prior written permission of the manufacturer. Installing additional equipment for placing tools or other materials on the platform, pedal plate or guardrail will increase the weight of the platform and the surface area of the platform or increase the load.
- 19) Do not modify or damage any parts that may affect the safety and stability of the vehicle.
- 20) Key parts that affect the vehicle's stability may not be replaced with parts of different weights or specifications.
- 21) Do not place the ladder or scaffolding in the platform or against any part of the vehicle.
- 22) Only tools and materials that are evenly distributed and can be safely moved by people on the platform can be transported.
- 23) Do not operate the vehicle on a moving surface or on a vehicle.
- 24) Make sure all tires are in good conditions and the nuts are properly tightened.
- 25) The ambient temperature in which the vehicle is operated is  $-20^{\circ}\text{C} \sim 40^{\circ}\text{C}$ .
- 26) The altitude of the workplace is below 1500m.
- 27) The allowable fluctuation of the vehicle's supply voltage is  $\pm 10\%$ .
- 28) Please replace the hydraulic oil as required temperature.
- 29) The maximum allowable working instantaneous wind speed is 12.5 m/s.
- 30) When the ambient temperature is  $40^{\circ}\text{C}$ , the relative humidity does not exceed 50%; the relative humidity is 90% when the ambient

temperature is 20°C.

- 31) The working support surface should be horizontal and solid, with a grounding pressure of 5.5Kg/cm<sup>2</sup>.
- 32) The total value of the vibration experienced by the small arm system shall not exceed 2.5 m/s<sup>2</sup>, and the highest root-mean-square value of the weighted acceleration experienced by the whole body shall not exceed 0.5 m/s<sup>2</sup>.
- 33) The noise level of ground working area is less than 107dB.

### 1.9 Risk of Crushing

- 1) Do not place arms, hands, or fingers in any position where there is a hazard of potential crushing.
- 2) When the machine is being operated from the ground using the control unit, use good judgment and carefully plan the travel path of the machine and boom. Keep a safe distance between the operator, machine and any fixed objects, walls, or buildings.

### 1.10 Risk of Operating on Slopes

Do not drive the vehicle on a slope that exceeds the vehicle's slope and side slope ratings. The slope rating applies to the vehicle that is in the retracted state.

Maximum slope rating, stowed position

|                   |           |
|-------------------|-----------|
| Platform downhill | 30% (17°) |
| Platform uphill   | 45% (24°) |
| Side slope        | 25% (14°) |



**Warning**

**When the vehicle is going downhill, select the slow speed mode (turtle) set at the upper control!**

### 1.11 Risk of Falling

- 1) During operation, the personnel on the

platform must wear the full body safety device and secure it with a seat belt hook to the approved rope attachment point. Only one hook can be tied to each rope attachment point.

- 2) Do not sit, stand or climb on the guardrail of the platform. Always stand on the platform floor firmly.



- 3) After the platform is lifted, the operator may not climb down the boom.
- 4) Keep the platform floor free of debris.
- 5) Lower the platform entry lifting rod or close the entry door before operating.
- 6) Do not operate the vehicle if the guardrail is not installed properly or the entrance door fails to guarantee safe operation.
- 7) Do not enter or exit the platform unless the vehicle is in the telescoped state.

### 1.12 Risk of Collision

- 1) When starting or operating the vehicle, pay attention to the blind spots within the line of sight.
- 2) When rotating the turntable, pay attention to the position of the boom and the tail of the turntable.
- 3) Check the work area to avoid obstacles or other possible hazards.

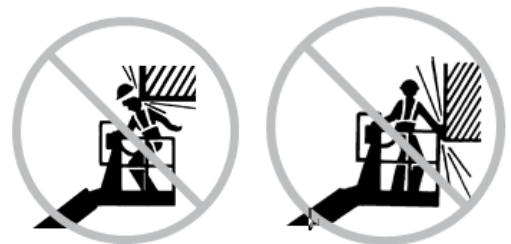

- 4) When holding onto the platform guardrail, be careful of the risk of crushing.
- 5) Lower the boom when there are no people

or obstacles in the area underneath.



- 6) Limit the drive speed according to the ground conditions, congestion levels, slope, personnel location and any other factors that may cause a collision.
- 7) It is not allowed to operate the machine on any crane or moving overhead vehicle route unless the crane control unit has been locked and/or precautions have been taken to prevent any potential collision.
- 8) When operating the machine, avoid any dangerous behaviors.
- 9) Users must abide by user rules, workplace rules and government rules regarding the use of personal protective equipment.
- 10) The direction arrows of the drive and steering function of the upper control box should be noted.

### **1.13 Risk of Component Damage**

- 1) Do not use any battery or charger greater than 12 V to start the engine.
- 2) Do not use the machine as the ground wire during welding.
- 3) Do not use the machine in the place where there may be magnetic field.

### **1.14 Risk of Explosion and Fire**

- 1) Do not operate the vehicle where it is dangerous or where flammable or explosive gases or particles may be present.
- 2) Do not start up the engine if liquefied petroleum gas (LPG), gasoline, diesel, or other explosive substances are present.

- 3) Do not refuel the machine when the engine is running.
- 4) Only refuel the machine in open and well-ventilated places far away from sparks, open flames, burning cigarettes, etc.

### **1.15 Risk of Machine Damage**

- 1) Do not operate a machine that is damaged or faulty.
- 2) Before each work shift, thoroughly perform the pre-operation inspection against the vehicle and test all functions. A damaged or faulty vehicle should be immediately tagged out and stopped.
- 3) Make sure all maintenance operations have been performed as specified in this manual.
- 4) Make sure all decals are properly positioned and easily identifiable.
- 5) Make sure this manual is stored in the manual box on the platform.

### **1.16 Risk of Bodily Injury**

- 1) Do not operate the vehicle with hydraulic oil leaks, which may penetrate when under pressure or burn your skin.
- 2) Incorrect contact with any component under the cover may cause serious injury. Only qualified authorized service personnel can access the compartment. It is recommended that the operator perform the inspection only during the pre-operation inspection. All compartments must be closed and locked during operation.
- 3) Always operate the machine in a well-ventilated area to avoid of carbon monoxide poisoning.

### **1.17 Battery Safety**

#### **Risk of Burns**

- 1) The battery contains acidic substances. Wear protective clothing and goggles when maintaining the battery.



- 2) Avoid spilling or touching the acid in the battery. Soda and water can be used to neutralize the spilled battery acid.
- 3) When the vehicle is not operated for a long time, turn off the main power switch.

### Risk of explosion



- 1) Sparks, flames and lit cigarettes are prohibited from getting close to the battery. The battery can release explosive gases.
- 2) Do not touch the battery terminals or cable clamps with tools that may cause sparks.

### Risk of Electric Shock/Burn

- 1) Avoid electric shock due to contact with battery terminals. Remove all rings, watches and other accessories.

## 1.18 Locked After Each Use

- 1) Choose a safe parking location that can be a solid, flat surface without obstructions or heavy traffic.
- 2) Telescope the boom and lower the platform.
- 3) Rotate the turntable to make the boom located between non-steering wheels.
- 4) Turn the key switch to the "OFF" position and remove the key to avoid any unauthorized use.
- 5) Disconnect the power switch when the machine is repaired or not used for a long period.

## 1.19 Check Tires and Wheels

This check item is conducted every 250 hours or once per quarter, whichever comes first.

Keeping tires and hubs in a good condition is critical for safe operation and good performance. Failure of the tires and hubs may cause the platform to tilt. If such failure is not found and repaired in time, it will also cause damage to platform parts.

- 1) Check treads and sides of tires for scratches, cracks, punctures, and other abnormal wear.
- 2) Check if the wheels are damaged, bent or cracked.
- 3) Check whether or not the sealing screws for tires are missing. If missing screws, if there is slight or no leakage of fillers, and no significant deformation is found for the tire body, and users can knock in screws which are slightly larger than the diameter (about 5mm/2in) of the vent hole with a hammer. If leakage of a large quantity of filler is found, and the tire body deforms significantly, lower the platform and replace the tires immediately.

## Chapter 2 Legend





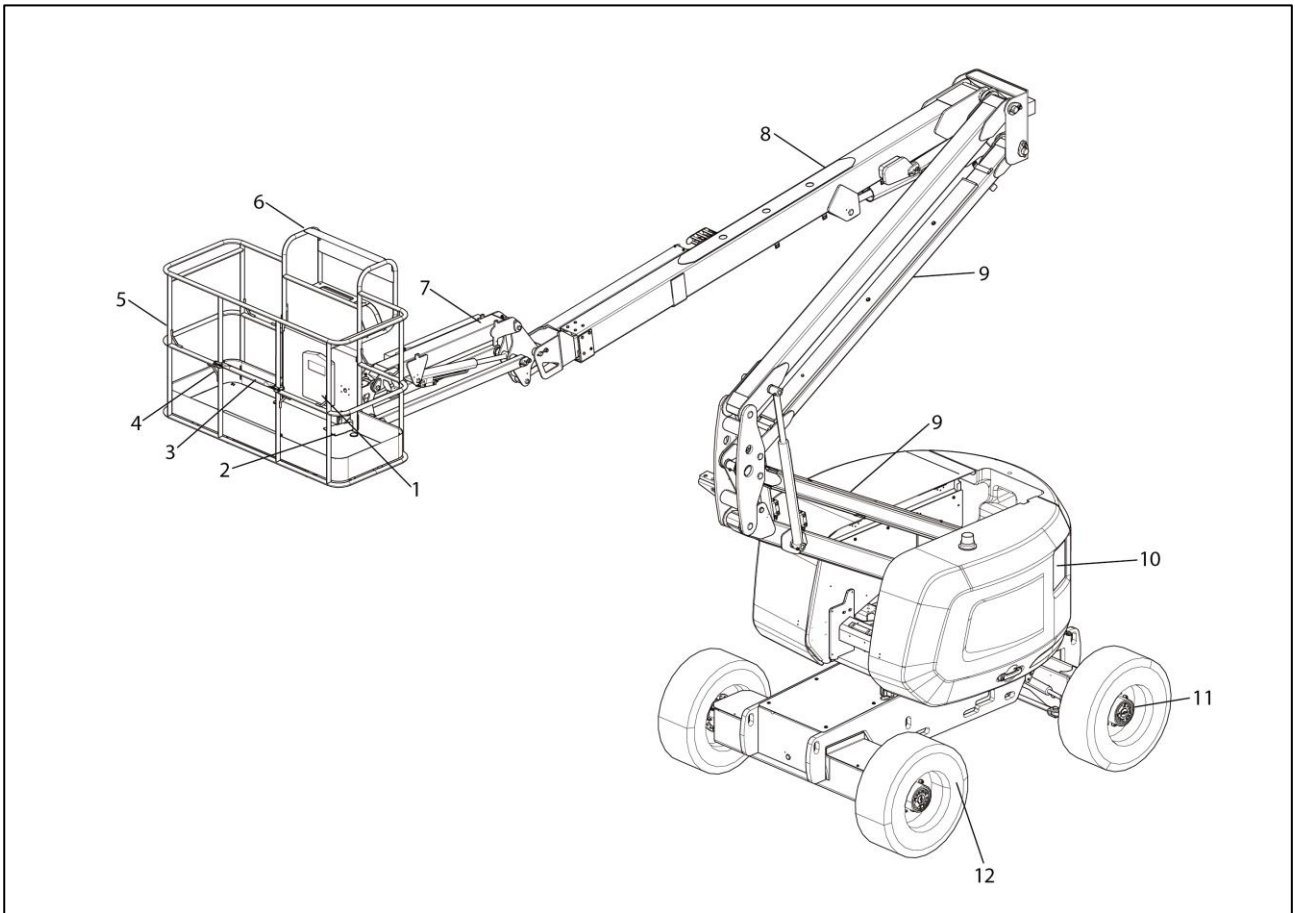

| No. | Name                 | No. | Name               |
|-----|----------------------|-----|--------------------|
| 1   | File Box             | 7   | Jib                |
| 2   | Foot Switch          | 8   | Base Boom Section  |
| 3   | Lifting Rod          | 9   | Tower Boom Section |
| 4   | Lanyard Fixing Point | 10  | Lower Control Box  |
| 5   | Platform             | 11  | Steering Wheel     |
| 6   | Upper Control Box    | 12  | Non-Steering Wheel |



## Chapter 3 Decals

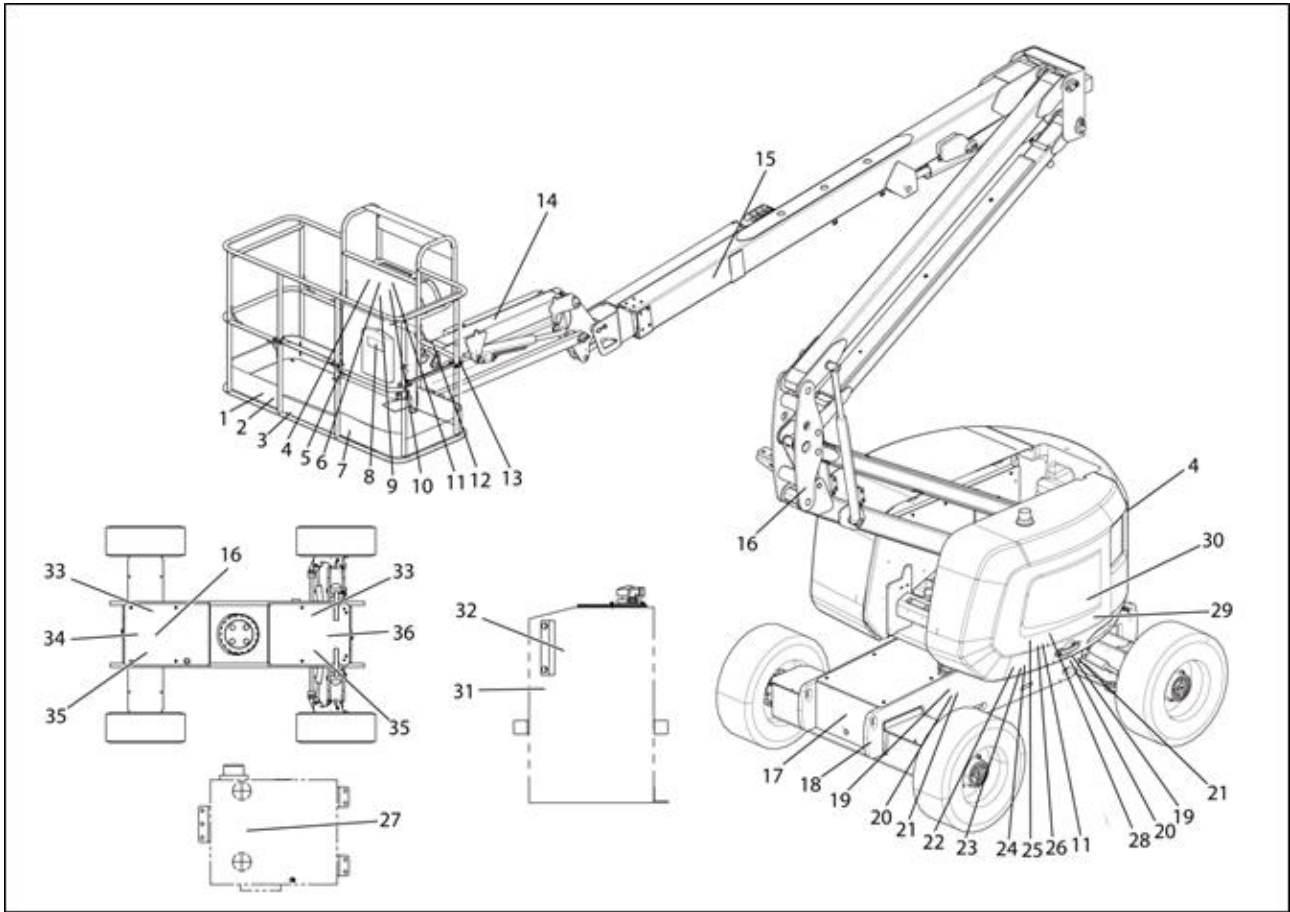

**Decals**

1-2534001559



2-2534001560

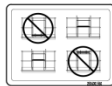

3-2534000024



4-2534001540



5-2534000248



6-2534001541



7-2534001565



8-2534001542

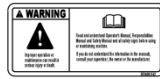

9-2534001762

NON-INSULATED

10-2534001570



11-2534000026



12-2534000017



13-2534001809



14-2534001180



15-2534001749



16-2534001545



17-2534000056

4x4

18-2534001178

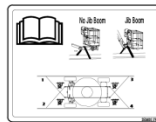

19-2534001848



20-2534001849



21-2534001578



22-2534001543



23-2534001558



24-2534001546



25-2534001548



26-2534000998



27-2534000177



28-2534001080

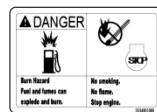

29-2534001807/0732

AR14J  
AR16J

30-2534000368



31-2534001995

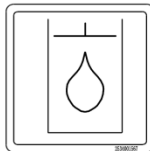

32-2534001377



33-2534000051



34-2534000052

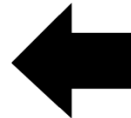

35-2534000050



36-2534000053



| No. | Code            | Name   |
|-----|-----------------|--|
| 1   | 2534001559      | Maximum hand power sign                              |
| 2   | 2534001560      | Middle guardrail lifting and lowering attention sign |
| 3   | 2534000024      | Warning line   |
| 4   | 2534001540      | Safety rules description sign                        |
| 5   | 2534000248      | Anti-scratch   |
| 6   | 2534001541      | Uphill and downhill tipping attention sign           |
| 7   | 2534001565      | Warning sign of platform safety                      |
| 8   | 2534001542      | Instructions reading sign                            |
| 9   | 2534001762      | No-insulated sign                                    |
| 10  | 2534001570      | Manual missing instruction                           |
| 11  | 2534000026      | Instructions reading sign                            |
| 12  | 2534000017      | Lanyard fixing point sign                            |
| 13  | 2534001809      | Anti-scratch   |
| 14  | 2534001180      | Anti-falling attention sign                          |
| 15  | 2534001749      | Group LOGO-LGMG                                      |
| 16  | 2534001545      | Anti-rollover danger sign                            |
| 17  | 2534000056      | Drive type identification                            |
| 18  | 2534001178      | Lanyard fixing point sign                            |
| 19  | 2534001848      | Tire change attention sign                           |
| 20  | 2534001849      | Wheel load sign                                      |
| 21  | 2534001578      | Anti-rollover attention sign                         |
| 22  | 2534001543      | Anti-crashing danger sign                            |
| 23  | 2534001558      | Pay attention to hazardous material                  |
| 24  | 2534001546      | Explosion burn warning sign                          |
| 25  | 2534001548      | Anti-electric shock warning sign                     |
| 26  | 2534000998      | "No fire" warning sign                               |
| 27  | 2534000177      | Fuel tank sign                                       |
| 28  | 2534001080      | "No fire" warning sign                               |
| 29  | 2534001807/0732 | Model mark   |
| 30  | 2534000368      | Group LOGO-right                                     |
| 31  | 2534001995      | Hydraulic oil sign                                   |
| 32  | 2534001377      | Hydraulic oil sign                                   |
| 33  | 2534000051      | Arrow sign   |
| 34  | 2534000052      | Arrow sign   |
| 35  | 2534000050      | Arrow sign   |
| 36  | 2534000053      | Arrow sign   |

Label

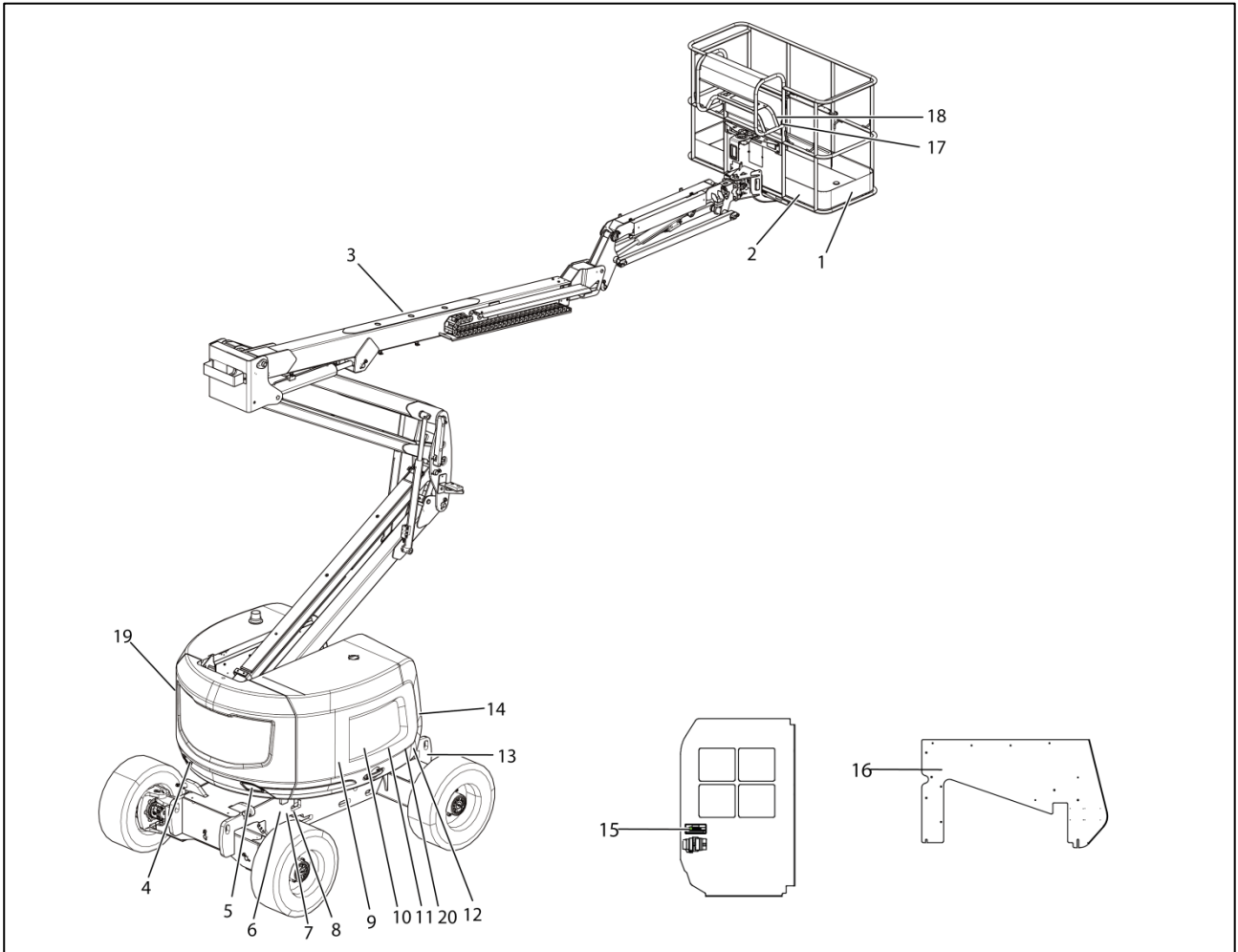



1-2534000024



2-2534001544



3-2534001808/0508

**AR14J**  
**AR16J**

4-2534000362



5-2534000363



6-2534001848



7-2534001849

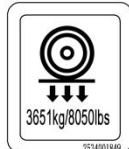

8-2534001578



9-2534001807/0732

**AR14J**  
**AR16J**

10-2534000367

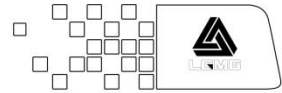

11-2534001548



12-2534000974



13-2534001178

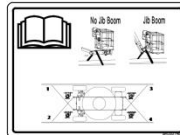

14-2534001545



15-2534002026

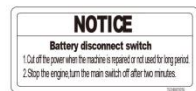

16-2534003058

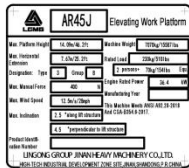

17-2534002551



18-2534002554/5

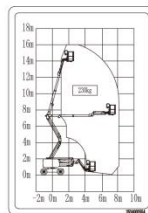

19-2534001576

**MADE IN CHINA**

20-2534000786



**Operation Manual of Elevating work platform**

| No | Code            | Name                                   |
|----|-----------------|--|
| 1  | 2534000024      | Warning line                           |
| 2  | 2534001544      | Keeping away from vehicle warning sign |
| 3  | 2534001808/0508 | Model sign                             |
| 4  | 2534000362      | Reflective sticker                     |
| 5  | 2534000363      | Reflective sticker                     |
| 6  | 2534001848      | Tire change attention sign             |
| 7  | 2534001849      | Wheel load sign                        |
| 8  | 2534001578      | Anti-rollover attention sign           |
| 9  | 2534001807/0732 | Model sign                             |
| 10 | 2534000367      | Company Logo-left                      |
| 11 | 2534001548      | Anti-electric shock warning sign       |
| 12 | 2534000974      | In-box maintenance attention sign      |
| 13 | 2534001178      | Lanyard fixing point sign              |
| 14 | 2534001545      | Anti-rollover attention sign           |
| 15 | 2534002026      | Power switch                           |
| 16 | 2534003058      | Vehicle nameplate                      |
| 17 | 2534002551      | Label-Slop rating                      |
| 18 | 2534002554/5    | Label- Range of motion                 |
| 19 | 2534001576      | Label-Original                         |
| 20 | 2534000786      | 107dB                                  |

## **Chapter 4 Specification**



Specification

**AR16J Vehicle parameters**

4.1 Vehicle performance parameters

| Item   | Parameter | Item  | Parameter |
|--|-----------|---|-----------|
| Rated load (kg)  | 230       | Turntable rotation by one circle(in the lifted state) (S) | 85-95     |
| Maximum number of people                               | 2         | Turntable rotation by one circle(in the stowed state) (S) | 85-95     |
| Vehicle weight (kg)                                    | 8180      | Boom lifting (S)  | 35-45     |
| Maximum working height (m)                             | 17.7      | Boom lowering (S)   | 32-42     |
| Maximum platform height (m)                            | 15.7      | Tower boom lifting (S)                                    | 25-35     |
| Maximum horizontal extension (m)                       | 9.39      | Tower boom lowering (S)                                   | 26-40     |
| Maximum span height (m)                                | 7.56      | Telescopic boom extended (S)                              | 20-30     |
| Minimum turning radius (inner wheel) (m)               | 1.94      | Telescopic boom telescoped(S)                             | 20-30     |
| Minimum turning radius (outer wheel) (m)               | 4.41      | Jib boom lifting (S)                                      | 30-50     |
| Vehicle speed (in the telescoped state) (km/h)         | 6.1±0.5   | Jib boom lowering (S)                                     | 20-35     |
| Vehicle speed (in the lifted state) (km/h)             | 0.8±0.05  | Platform rotation (S)                                     | 13-26     |
| Vehicle climbing speed(in the telescoped state) (km/h) | >1.5      | Theoretical climbing ability                              | 45%       |
| Vehicle climbing speed(in the lifted state) (km/h)     | ≤0.8      | Maximum manual force(N)                                   | 400       |
| Maximum allowable tilt angle                           | 4.5°      | Maximum wind speed  | 12.5      |

4.2 Main dimensions

| Item                             | Parameter | Item  | Parameter |
|----------------------------------|-----------|---|-----------|
| Vehicle length (mm)              | 7560      | Wheelbase (mm)                                  | 2059      |
| Vehicle width (mm)               | 2310      | Track width (mm)                                | 1981.5    |
| Vehicle height (mm)              | 2170      | Ground clearance (in the telescoped state) (mm) | 360       |
| Working platform size (L×W) (mm) | 1830×760  | Tire specification                              | 315/55D20 |

4.3 Engine System

| Item              | Parameters/Contents | Item                               | Parameters/Contents |
|-------------------|---------------------|------------------------------------|---------------------|
| Model             | D2.9L4              | Rated speed (r/min)                | 2,600               |
| Displacement (ml) | 2900                | Maximum torque (N.m)/speed (r/min) | 150/1,600           |
| Rated power (KW)  | 36.4                | Emission standard                  | EU stage V          |

#### 4.4 Drive system

| Item            |                     | Parameter/Content |
|-----------------|---------------------|-------------------|
| Walking reducer | Output torque (N*m) | 3500              |
| Rotary reducer  | Output torque (N*m) | 8729              |

#### 4.5 Hydraulic system

| Item            |                             | Parameter/Content      |      |
|-----------------|-----------------------------|------------------------|------|
| Walking system  | Type                        | Closed system          |      |
|                 | Working pressure (Mpa)      | 28                     |      |
|                 | Displacement of pump(ml/r)  | 46                     |      |
|                 | Displacement of motor(ml/r) | 38                     |      |
| Function system | Type                        | Open system            |      |
|                 | Displacement of pump(ml/r)  |                        | 11   |
|                 | Lifting system(Mpa)         | Working pressure (Mpa) | 23.5 |
|                 | Rotary system               | Working pressure (Mpa) | 23.5 |
|                 | Steering system             | Working pressure (Mpa) | 23.5 |

#### 4.6 Electric system

| Item           |                    | Parameter/Content |
|----------------|--------------------|-------------------|
| Battery        | Model              | 6-QW-120B         |
|                | Output voltage (V) | 12                |
|                | Capacity ( AH)     | 120(20 hours)     |
| Control system | Voltage (V)        | 12                |

#### 4.7 Oil filling capacity

| Item              | Parameters |
|-------------------|------------|
| Hydraulic oil (L) | 130        |
| Engine oil (L)    | 8.5        |
| Diesel(L)         | 65         |
| Reducer (L)       | 0.68*4     |
| Coolant(L)        | 8.5        |

Note: When hydraulic oil and diesel are filled, it is necessary to use the corresponding hydraulic oil and diesel according to operating environment and temperature, and refer to the following contents:

| Item             | Condition                              | Oil viscosity brand                        | Oil mass | Remarks                   |
|------------------|--|--|----------|---------------------------|
| Hydraulic oil(L) | The lowest temperature > -25°C         | L-HV32 Low temperature hydraulic oil       | 130      | Recommended chevron brand |
|                  | -40°C < The lowest temperature ≤ -25°C | L-HS32 Ultra low temperature hydraulic oil |          |                           |
|                  | The lowest temperature ≤ -40°C         | 10# Aviation                               |          |                           |

|                       |   | hydraulic oil  |      |                         |
|-----------------------|---|--|------|-------------------------|
| Reducer oil ×<br>4(L) | 30° C < The lowest temperature  | 85W/140  | 0.68 | SAE API<br>1560<br>GL-5 |
|                       | -10° C < The lowest temperature <<br>30° C  | 85W/90   |      |                         |
|                       | -30° C < The lowest temperature <<br>-10° C   | 80W/90   |      |                         |
|                       | The lowest temperature < -30° C   | 75W  |      |                         |
| Engine oil(L)         | Working temperature: -20°C ~ 40°C   | CH-4/15W-40  | 8.5  | /                       |
|                       | Working temperature: -25°C ~ 30°C   | CH-4/10W-30  |      |                         |
|                       | Working temperature: -30°C ~ 30°C   | CH-4/5W-30   |      |                         |
|                       | Working temperature: -35°C ~ 20°C   | CH-4/0W-20   |      |                         |
| Diesel (L)            | The lowest temperature ≥ 4°C<br>The lowest temperature ≥ -5°C<br>The lowest temperature ≥ -14°C<br>The lowest temperature ≥ -29°C | 0 #Diesel<br>-10 #Diesel<br>-20 #Diesel<br>-35 #Diesel | 65   |                         |
| Coolant (L)           |   | /  | 8.5  |                         |

#### 4.8 Range of motion

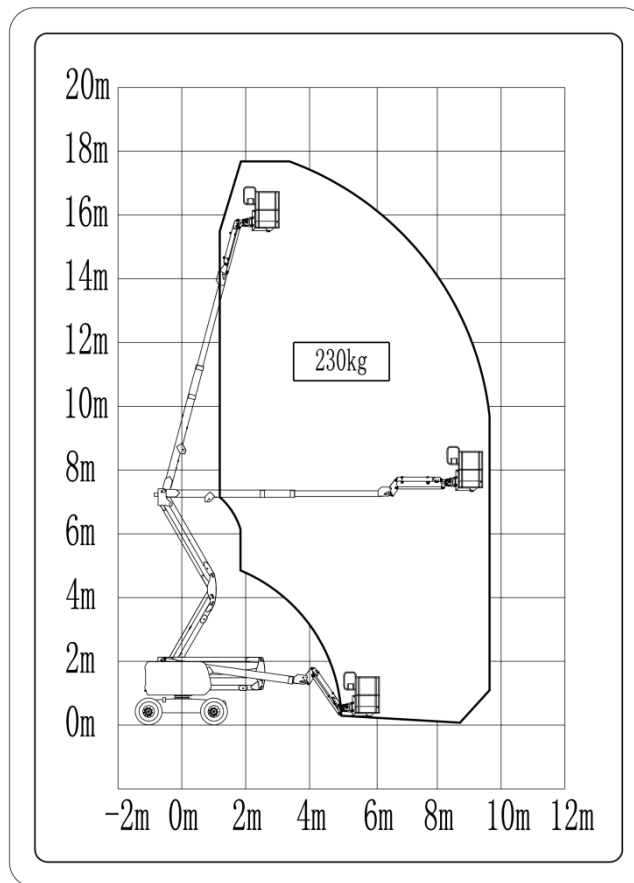





## **Chapter 5 Control Unit**





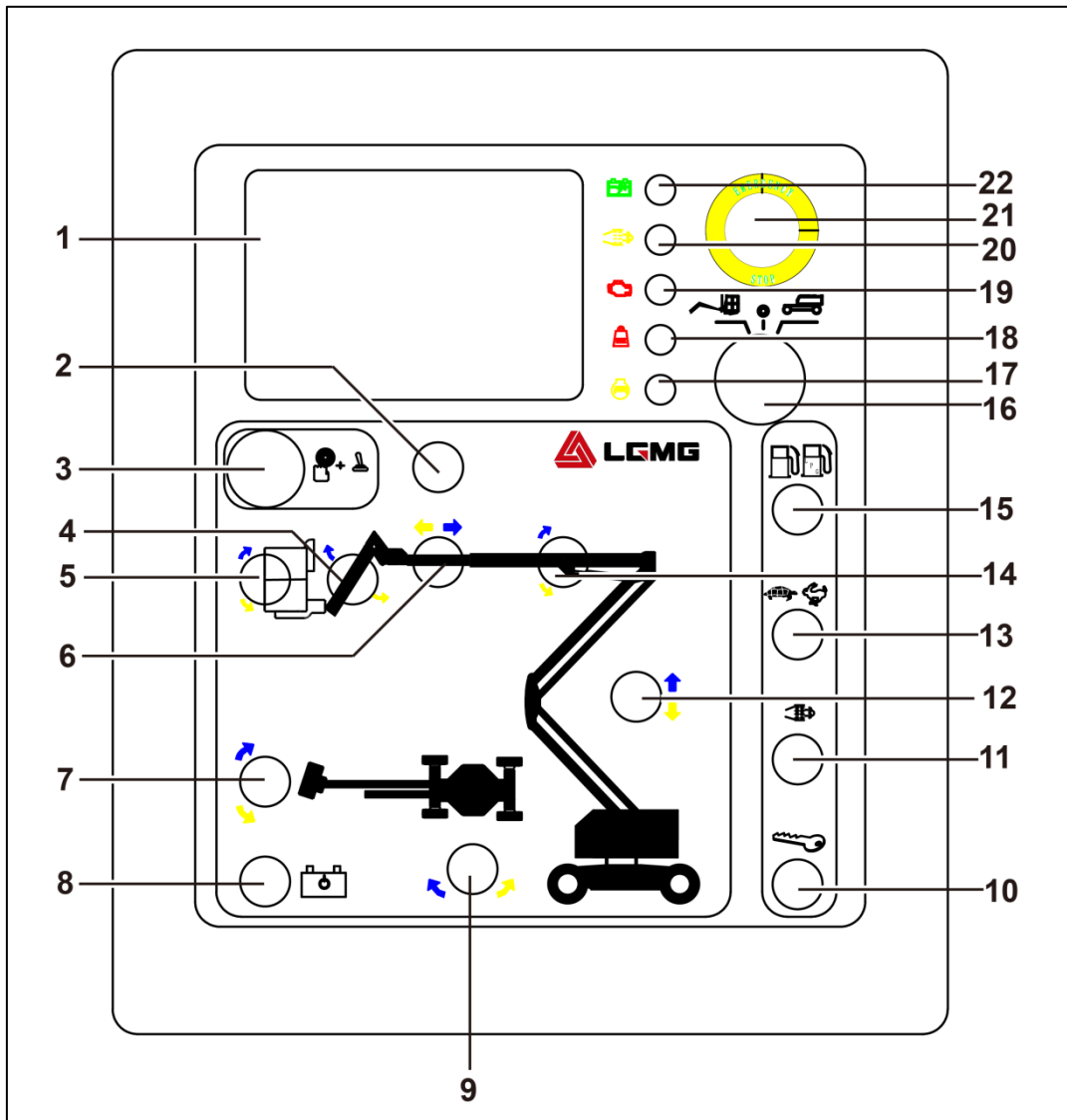



## 5.1 Lower Control Box



| No. | Name   | No. | Name                                    |
|-----|--|-----|---|
| 1   | Display                                      | 12  | Tower Boom Up/Down Switch               |
| 2   | Self-Resetting Fuse For Controlling Circuit  | 13  | Engine Idle Speed (Rpm) Selector Switch |
| 3   | Function Enable Switch                       | 14  | Base Boom Up/Down Switch                |
| 4   | Jib Boom Up/Down Switch                      | 15  | Fuel Selector Switch(If equipped)       |
| 5   | Platform Leveling Switch                     | 16  | Key switch                              |
| 6   | Base boom extend/retract Switch              | 17  | Engine warm up indicator                |
| 7   | Platform Swing Button                        | 18  | Platform overweight alarm               |
| 8   | Emergency Power Unit Switch                  | 19  | Engine failure alarm                    |
| 9   | Turntable Rotation Switch                    | 20  | Regeneration indicator (If equipped)    |
| 10  | Engine Start Switch                          | 21  | Emergency Stop Button Switch            |
| 11  | Manual DPF regeneration switch (If equipped) | 22  | Power on indicator                      |

The functional description of the lower control box button switch is as follows:

| Item                                   | Button switch   | Functional description   |  |
|--|---|--|--|
| Lower Control Box                      | Key Switch  | When turning the key switch to the “Platform” position, the upper control box will be enabled. When turning the key switch to the “OFF” position, the vehicle will stop. Turn the key switch to the “Ground” position and the lower control box will be enabled.                       |  |
|  | Emergency Stop Button Switch  | When pushing the red “Emergency Stop” button inward to the “OFF” position, all functions can be disabled. When each function control handle or button switch of the vehicle is enabled, all functions will not be enabled.   |  |
|  |   | When pulling the red “Emergency Stop” button to the “ON” position, the vehicle can be operated and the warning light should flash.   |  |
|  | Function Enable Button Switch   | Do not press and hold the function button enable switch, try to activate each boom and platform function button switch. The boom and platform functions will not be enabled.   |  |
|  |   | When pressing and holding the function enable button and activating each boom and platform function button switch, the boom and platform functions should operate for a full cycle.  |  |
|  | Engine Start Switch   | Move the engine start switch to one side to start the engine.  |  |
|  | Emergency Lowering Switch   | Use auxiliary power if the primary power source (engine) fails. Simultaneously hold the auxiliary power switch to upper side and activate the desired function.  |  |
|  |   |  | <ol style="list-style-type: none"> <li>1. Turn the key button switch to the lower control box.</li> <li>2. Pull the red “Emergency Stop” button outward to the “ON” position.</li> <li>3. Press and hold the enable button.</li> </ol> |
|  | Platform Swing Switch   |  <p>When moving the platform swing button switch upward, the platform will rotate to the left. When moving the platform rotation button switch downward, the platform will rotate to the right.</p> |  |
|  | Turntable Rotate Switch   |  <p>When turning the button switch to the right, the turntable will move to the right. When moving the button to the left, the turntable will move to the left.</p>                                 |  |
| Base Boom Lifting/Lowering Switch      |  <p>When pulling the button switch upward, the boom will be lifted. When pulling the button switch downward, the boom will be lowered. The lowering alarm should sound when the boom is lowered.</p> |  |  |
| Base Boom Extending/Telescoping Switch |  <p>When pulling the button switch to the left, the boom will be extended.<br/>When pressing the button switch to the right, the boom will be telescoped.</p>  |  |  |



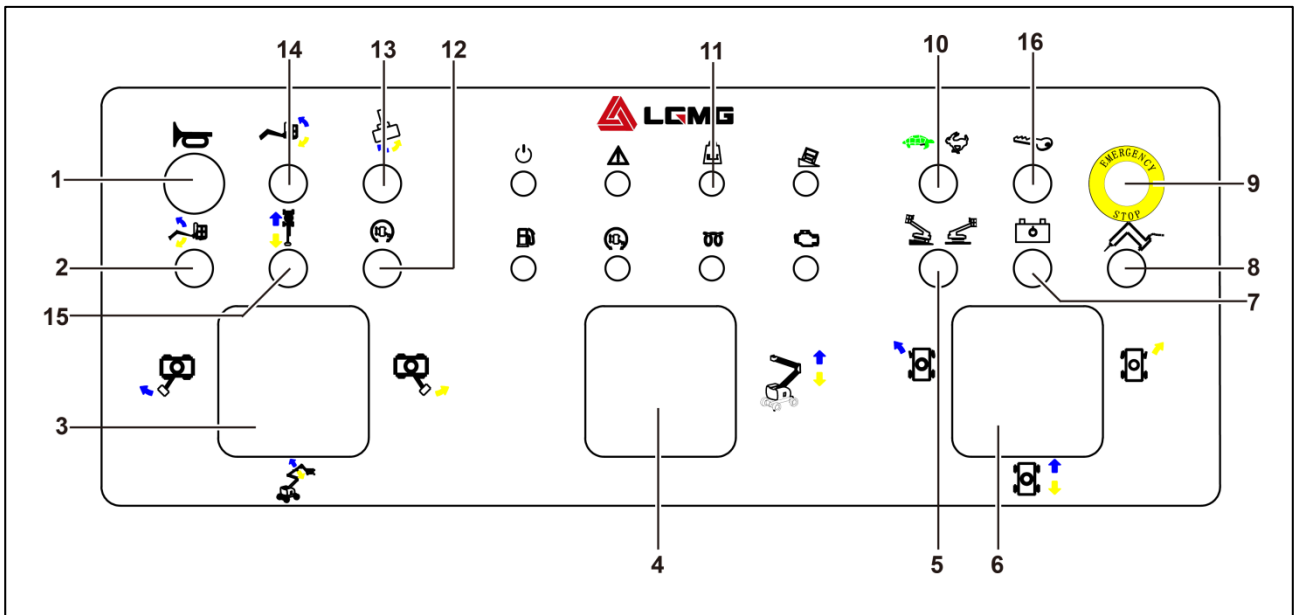

|  |   |   |
|--|---|---|
|  | <p>Tower boom section lifting/lowering Switch</p> |  <p>When pulling the button switch upward, the tower boom section will be lifted. When pulling the button switch downward, the tower boom section will be lowered. The lowering alarm should sound when the boom is lowered.</p> |
|  | <p>Platform Leveling Switch</p>                   |  <p>When pulling the platform leveling button switch upward, the level of the platform will rise. When pulling the platform leveling button switch downward, the level of the platform will lower.</p>                           |
|  | <p>Jib Boom up/down Switch</p>                    |  <p>When pulling the button switch upward, the Jib boom will be lifted. When pulling the button switch downward, the Jib boom will be lowered.</p>   |





## 5.2 Upper Control Box











| No. | Name  | No. | Name                                      |
|-----|---|-----|---|
| 1   | Horn Button                                     | 9   | Emergency Stop Switch                     |
| 2   | Jib Up/Down Button                              | 10  | Engine Idle Speed Selector Switch         |
| 3   | Base Boom Up/Down and Turntable Rotation Switch | 11  | Indicator                                 |
| 4   | Tower Boom Up/Down Switch                       | 12  | Drive Enable Button Switch                |
| 5   | Drive Speed Selector Switch                     | 13  | Platform Swing Switch                     |
| 6   | Drive/Steering Control Handle                   | 14  | Platform Leveling Switch                  |
| 7   | Emergency Power Unit                            | 15  | Base boom Extension And Retraction switch |
| 8   | Generator Switch(If equipped)                   | 16  | Engine Start switch                       |

The functional description of the upper control box button switch is as follows:

| Item              | Button switch  | Functional description   |
|-------------------|--|--|
| Upper control box | Emergency Stop Button Switch   | <p>When pushing the red “Emergency Stop” button inward to the “OFF” position, all functions can be disabled. When each function control handle or button switch of the vehicle is activated, all functions cannot be enabled.</p> <p>When the red "Emergency Stop" button is pulled to the “ON” position, the vehicle can be operated.</p>   |
|                   | Engine Start Switch  | Move the engine start switch to one side to start the engine.  |
|                   | Foot Switch  | <p>The foot switch may not be pressed and each function of the vehicle should be enabled. As a result, the vehicle function cannot be enabled.</p> <p>When the foot switch is pressed to activate each function control handle or button switch of the vehicle, all boom and platform functions should operate for a full cycle.</p>   |
|                   | Emergency Power Unit Switch  | If the main power source (engine) fails, use the emergency power unit. Step on the foot switch to start the required functions while keeping the emergency power switch on.  |
|                   | Generator Switch (If equipped)   | Move the switch to turn the generator on. Move the switch again to turn the generator off.   |
|                   | Horn Button  | When the horn button is pressed, the horn will sound. When the horn button is released, the horn will stop ringing.  |
|                   | <ol style="list-style-type: none"> <li>1. Turn the key button switch to the upper control box.</li> <li>2. Pull the red “Emergency Stop” button outward to the “ON” position.</li> <li>3. Press the foot button switch.</li> </ol> |  |
|                   | Platform Swing Switch  |  <p>When moving the platform Swing button switch to the right, the platform will rotate to the right. When moving the platform rotation button switch to the left, the platform will rotate to the left.</p>  |
|                   | Base boom Lifting/Lowering/ and Turntable Left/Right Rotation  |  <p>When moving the control handle to the right, the turntable will move to the right. When moving the control handle to the left, the turntable will move to the left.</p>  <p>When moving the control handle up, the boom will be lifted. When moving the control handle downward, the boom will be lowered. The lowering alarm should sound when the boom is lowered.</p> |
|                   | Base boom extend/retract switch  |  <p>Move the switch down and the boom will extend. Move the switch up and the boom will retract.</p>  |
|                   | Tower Boom Section Lifting/Lowering Switch   |  <p>When pulling the button switch upward, the tower boom section will be lifted. When pulling the button switch downward, the tower boom section will be lowered. The lowering alarm should sound when the boom is lowered.</p>  |

|  |  |
|--|--|
| <p>Jib Lifting/Lowering Switch</p>       |  <p>When pulling the button switch upward, the Jib will be lifted. When pulling the button switch downward, the Jib will be lowered.</p>  |
| <p>Platform Leveling Switch</p>          |  <p>When pulling the platform leveling button switch upward, the platform level will be lifted. When pulling the platform leveling button switch downward, the platform level will drop.</p>  |
| <p>Drive/Steering Control Handle</p>     | <p>When moving the control handle upward, the vehicle will drive forward. When moving the control handle downward, the vehicle will drive backward. When pressing the left side of the thumb rocker, the vehicle will turn to the left. When pressing the right side of the thumb rocker, the vehicle will turn to the right.</p>  |
| <p>Drive Enable Switch</p>               |  <p>Press the foot switch and lower the boom to the telescoped position. Rotate the turntable until the boom moves over more than one non-steering wheel. As a result, the drive enable indicator should be lit at any position within the range shown in the figure. When moving the drive control handle to the center position, the drive function will not be enabled. When moving the drive enable button switch to one side and slowly moving the drive control handle away from the center position, the drive function should be enabled.</p> <p>Note: When operating the drive enable system, the vehicle can drive in the opposite direction of drive and steering control handle movement.</p> |
| <p>Engine Idle Speed Selector Switch</p> |  <p>Pull the idle speed selector switch to the turtle position, the engine starts the low idle speed; Pull the idle speed selector switch to the rabbit position, step on the foot switch and turn the handle, then the engine starts the high idle speed. After releasing the handle, the engine enters the low idle speed.</p>  |

The table below describes the functions of the LED display panel and indicators:

|   |  |  |                                 |
|---|--|--|---------------------------------|
|  | <p>Platform overweight alarm</p>             |  | <p>Minimum fuel level alarm</p> |
|  | <p>Drive enabling alarm</p>                  |  | <p>System failure alarm</p>     |
|  | <p>Machine tilt alarm</p>                    |  | <p>Engine failure alarm</p>     |
|  | <p>Generator is in use<br/>(If equipped)</p> |  | <p>Glow plugs are on</p>        |



## **Chapter 6 Pre-Operation Inspection**



## 6.1 No Operation Is Allowed Unless

You have understood and practiced the principles about safe operation of the vehicle in this manual.

- 1) Avoid dangerous situations.
- 2) Always perform a pre-operation inspection. You should understand pre-operation inspection before proceeding with the next step.
- 3) Check the workplace.
- 4) Always perform a pre-use functional test.
- 5) Use the vehicle only for its intended purpose.

## 6.2 Basic Principles

- 1) It is the operator's responsibility to perform pre-operation inspection and routine maintenance.
- 2) Pre-operation inspection is a very intuitive process that is performed by the operator before each shift. The purpose of the inspection is to determine if there is a significant problem with the vehicle before the operator performs a functional test.
- 3) Pre-operation inspection can also be used to determine if a routine maintenance procedure is necessary. The operator can only perform the routine maintenance items specified in this manual.
- 4) See the checklist on the next page and check each item.
- 5) In the event of any damage or any unauthorized changes different from the normal status, the vehicle should be marked and prohibited from putting into operation.
- 6) Only qualified authorized service technicians are allowed to maintain the vehicle according to the manufacturer's instructions. After the maintenance is completed, the operator must perform a pre-operation inspection again before continuing the functional test.

- 7) Regular maintenance inspections should be performed by qualified authorized service technicians according to the manufacturer's specifications and the requirements listed in the responsibilities manual.

## 6.3 Pre-Operation Inspection

- 1) Make sure the manual is complete, easy to read, and stored in the manual box on the platform.
- 2) Make sure all decals are clear, legible, and in the right place. See the label section.
- 3) Check hydraulic oil for leakage and appropriate oil level. fill the oil as needed. See the "Maintenance" section.
- 4) Check the battery fluid for leakage and appropriate liquid level. Add the distilled water as needed. See the "Maintenance" section.
- 5) Check the following parts or areas for damage, improper installation, parts missing or unauthorized changes:
  - Electrical components, wires and cables
  - Valve block, hose, joint, cylinder
  - Hydraulic and fuel tank
  - Drive motor, Swing motor and drive hub
  - Boom wear pad
  - Tires and wheels
  - Limit button switch, tilt sensor and horn
  - Nuts, bolts and other fasteners
  - Platform overload components
  - Platform entrance lifting rod
  - Alarm light
  - Platform control handle
  - Engine and parts
- 6) Check the entire vehicle for the followings:
  - Crack in a weld or structural member
  - Dent or damage to the vehicle
  - Make sure all structural members and

other critical components are complete, and all associated fasteners and pins are in the right position and tightened.

- After completing the inspection, make sure all compartment covers are properly secured and locked.

## **Chapter 7 Workplace Inspection**



## 7.1 No Operation Is Allowed Unless

You have understood and practiced the principles about safe operation of the vehicle in this manual.

- 1) Avoid dangerous situations.
- 2) Always perform a pre-operation inspection.
- 3) Check the workplace. You should understand pre-operation inspection before proceeding with the next step.
- 4) Always perform a pre-use functional test.
- 5) Use the vehicle only for its intended purpose.

## 7.2 Basic Principles

- 1) Workplace inspection will help the operator determine if the workplace is safe for operation of the vehicle. The operator should perform pre-operation inspection before moving the vehicle to the workplace.
- 2) It is the operator's responsibility to understand and remember the hazards in the workplace and to be aware of and avoid these hazards when moving, installing and operating the vehicle.

## 7.3 Workplace Inspection

Be aware of and avoid the following dangerous situations

- 1) Steep slope or cave
- 2) Protrusions, ground obstacles or debris
- 3) Inclined surface
- 4) Unstable or smooth surface
- 5) Overhead obstacles and high voltage wires
- 6) Dangerous location
- 7) Surface support that is not sufficient to withstand the full load applied by the vehicle
- 8) Wind and weather conditions
- 9) Unauthorized personnel
- 10) Other possible unsafe conditions





## **Chapter 8 Functional Test**



## 8.1 No Operation Is Allowed Unless

You have understood and practiced the principles about safe operation of the vehicle in this manual.

- 1) Avoid dangerous situations.
- 2) Always perform a pre-operation inspection.
- 3) Check the workplace.
- 4) Always perform a pre-use functional test.
- 5) You should understand the functional test and inspection before proceeding with the next step.
- 6) Use the vehicle only for its intended purpose.

## 8.2 Basic Principles

- 1) Functional tests are used to detect faults before operating the vehicle.
- 2) The operator must follow the steps to test all the functions of the vehicle.
- 3) Do not use a malfunctioning vehicle. If a fault is found, the vehicle must be marked and stopped.
- 4) Only qualified authorized service technicians are allowed to maintain the vehicle according to the manufacturer's instructions.
- 5) After maintenance is completed, the operator must perform the pre-operation inspection and functional test again before operating the vehicle.

## 8.3 Functional Test

- 1) Choose a test place that is solid, level and free of obstacles.

## 8.4 Tests from the Lower Control Box

- 1) Turn the key button switch to the position of the lower control box.
- 2) Pull out the red "emergency stop" button to the "ON" position, and the warning light will begin to flash.

- 3) Refer to the "Operation Instructions" section to start the engine.

### Test of emergency stop

- 1) Push the ground red "Emergency Stop" button inward to the "OFF" position.
- 2) Result: The engine is off and none of the functions work.
- 3) Pull the red emergency stop button to the "on" position and restart the engine.

### Test of vehicle function

- 1) Do not press and hold the function enable button switch. Try to enable each boom and platform function button switch.

Result: No boom and platform function can be enabled.

- 2) Press and hold the function enable button and activate each boom and platform function button switch.

Result: The boom and platform functions should operate for a full cycle. When the boom is lowered, the lowering alarm (if equipped) should sound.

### Test the Function of the Emergency Power Unit



**Caution: Perform this step when the engine is off. In order to save battery energy, test each function in half a cycle.**

- Turn the key switch to the ground control and pull the red emergency stop button out to the "on" position.
- At the same time, press the emergency power unit switch to the on position and start each boom function switch.

Result: All boom functions are operational.

### Inspect the Automatic Leveling of the Work Platform

- Start the engine from the ground.
- Press the function enable switch and use the platform leveling toggle switch to adjust the work platform to the horizontal position.

- Raise and descend the boom through a full cycle.

Result: The work platform is always level.

## 8.5 Tests from the Upper Control Box

### Test the Emergency Stop

- Push the platform red "Emergency Stop" button to the "OFF" position.
- Enter the platform to pull out the red "emergency stop" button and start the engine.
- Push the red "emergency stop" button of the platform to the off position.

Result: The engine is off and no function can be operated.

### Test the Horn

- Press the horn button.

Result: The horn sounds.

### Test the Foot Switch

- Push the red "emergency stop" button of the platform to the off position.
- Rotate the red "emergency stop" button to the on position and do not start the engine.
- Press down the foot switch and try to start the engine by pulling the start toggle switch to either side.

Result: The engine does not start.

- Do not press the foot switch and restart the engine.

Result: The engine start.

- Do not press the foot switch and test the machine's functions.

Result: None of the functions are running.

### Test the Machine Function

- Press down the foot switch.
- Start each function control handle or toggle switch on the machine.

Result: All boom/platform actions work properly in one full cycle.

### Test the Auxiliary Power Function

 **Caution: Perform this step when the engine is off. In order to save battery energy, test each function in half a cycle.**

- Turn the key switch to the work platform control.
- Turn the red emergency stop button to the "on" position on the work platform control and press the foot switch.
- Press the emergency power unit switch to the "on" position and turn on each function control handle or toggle switch.

Result: All boom and steering functions and drive functions do not function.

### Test the steering

- Press down the foot switch.
- Press the left side of the thumb stick switch on the top of the drive control handle.
- Press the right side of the thumb stick switch on the top of the drive control handle.

### Test the Drive and Brake Function

- Press down the foot switch.
- Move slowly the drive control handle forward until the machine begins to move, and then return the handle to the center position.

Result: The machine stopped suddenly.

- Move slowly the drive control handle backward until the machine begins to move, and then return the handle to the center position.

Result: The machine stopped suddenly.

 **Caution: The brakes must be able to stop the machine on any slope that it can climb.**

### Test the Tilt Angle Sensor

- Start the engine and drive the machine to a certain slope, then make the turntable tilt 4.5° along the direction of the boom.

Result: The alarm on the platform sounds.

- Drive the machine to a certain slope, and then make the machine tilt 4.5° degrees at a right angle to the boom.

Result: The alarm on the platform sounds.

- Drive the machine to a certain slope to make the alarm sound.
- Start all boom functions in succession.
- Operate the handle to start the turntable Swing function.

Result: After raising the main boom to a 0.9m, it cannot continue to change amplitude up wards. After raising the tower boom section to a 0.9m, it cannot continue to change amplitude up wards. The base boom section cannot continue to extend after an extension of 0.6m. The rest of the boom functions can be used normally, the turntable cannot be rotated.



**Caution: If the turntable tilts 4.5°**

**along the direction of the boom or 4.5 along the vertical direction of the boom, the main boom or the tower boom section can be raised more than 0.9m, or the base boom section can extend more than 0.6 m. The machine should be marked immediately and stopped using.**

### Test the Axle Oscillation Cylinder

- Start the engine on the platform.
- Drive the right steering wheel to a 15cm/5.9in high obstacle or curb.

Result: The other three tires are in close contact with the ground.

- Drive the left steering wheel to a 15cm/5.9in high obstacle or curb.

Result: The other three tires are in close contact with the ground.

- Drive the left rear wheel to a 15cm/5.9in high obstacle or curb.

Result: The other three tires are in close contact with the ground.

- Drive the right rear wheel to a 15cm high obstacle or curb.

- Result: The other three tires are in close contact with the ground.

### Test the Drive Enabling System



Figure 8-1 Drive enabling

- Press down the foot switch and lower the boom to the retracted state.

- Rotate the turntable until the boom is turned to a certain angle, as shown in Figure 8-1.

Result: The drive enabling indicator should be illuminated when the boom is at any position within the range shown.

- Move the drive control handle away from the center position.

Result: The drive function does not work.

- Move the drive enabling toggle switch to the upper side while slowly moving the drive controller handle away from the center position.

Result: The drive function can be operated.



**Caution: When using the drive**

**enabling system, the machine may travel in the opposite direction of travel and steering control handle movement. Use the color-coded direction arrows on the drive chassis to determine the direction of movement.**

### Test the Limited Drive Speed

- Press down the foot switch.
- Raise the base boom section 0.9m.
- Move slowly the drive control handle to the full drive position.

Result: When the base boom section is lifted, the maximum drive speed that can be achieved does not exceed 0.8km/h.

- Lower the base boom section to the retracted state
- Raise the folding boom 0.9m.
- Move slowly the drive control handle to the full drive position.

Result: When the folding boom is in the extended state, the maximum drive speed that can be achieved does not exceed 0.8km/h.

- Descend the folding boom to the retracted state
- Extend the base boom section by about 0.6m.
- Move slowly the drive control handle to the full drive position.

Result: When the boom is in the extended state, the maximum drive speed that can be achieved does not exceed 0.8km/h.



**Caution: If the drive speed of the boom when it is raised or extended exceeds 0.8km/h, the machine should be tagged out immediately and stopped.**



**Caution: If the time it takes the boom to rotate for a circle in the extended state is less than 85s (AR16J), the machine should be marked immediately and stopped.**

#### **Test the Drive/Boom Function**

- Press down the foot switch.
- Move the drive control handle away from the center position and start a boom function handle or toggle switch.

Result: All boom functions should be operational.  
The machine moves in the direction indicated on the control panel.

## **Chapter 9 Operating Instructions**





## 9.1 No Operation is Allowed Unless

You have understood and practiced the principles about safe operation of the machine in this manual.

- 1) Avoid dangerous situations.
- 2) Always perform a pre-operation inspection.
- 3) Check the workplace.
- 4) Always perform a pre-use functional test.
- 5) Use the machine only for its intended purpose.

## 9.2 Basic Principles

- 1) The vehicle is a self-propelled hydraulic drive lifting device which is equipped with a working platform on an articulating boom mechanism. The vibration generated when the vehicle is running will not be dangerous to the operator who stands on the work platform. The vehicle can be used to load workers and their portable tools to a certain height from the ground, or to reach a certain working area above the vehicle or equipment.
- 2) The Operating Instructions section provides specific instructions for all aspects of vehicle operation. It is the operator's responsibility to follow all safety rules and instructions in this manual.
- 3) This machine is designed for lifting workers and tools to the overhead workplace, it is unsafe or even dangerous to use the vehicle for other purposes.

 **Caution: This vehicle is strictly**

**prohibited from carrying loads.**

- 4) Only trained and authorized personnel can operate the vehicle. If more than one operator uses the same vehicle at different times during the same work shift, they must be qualified operators and follow all safety rules and instructions in the Operation and Maintenance Manual. This means that every new operator should perform

pre-operation inspections, functional tests and workplace inspections before operating the vehicle.

## 9.3 Starting the Engine

- 1) From the ground control station, turn the key switch to the required position.
- 2) Ensure red "Emergency Shutdown" buttons on the lower control box and the upper control box are pulled to the ON position.
- 3) During startup at low temperature, turn the preheat switch to the other side, keep it activated for 5s to 10s, then turn back the switch and stop preheating.

The engine (Deutz D2.9L4) can be automatically preheated at low temperatures when the whole vehicle is powered on.

- 4) Turn the engine startup switch to either side for 2s to 3s. If the engine fails to start or starts up and then stalls immediately, disenable the startup switch for 3s.
- 5) If the engine fails to start 15s, diagnose the reason and repair the fault. Wait for 60s before trying to restart the engine.
- 6) Before operation, the engine shall be idled for 5 minutes to ensure it sufficiently lubricated in case of hydraulic system damage.
- 7) At temperatures lower than  $-18^{\circ}\text{C}$ , a boosting battery may be used to try and start the engine.



**Caution: Upon the normal**

**running of the engine, do not start up again.**

## 9.4 Emergency Stop

- 1) Push the red emergency shutdown button on the ground or upper control box to the "OFF" position to stop all functions and shut down the engine.
- 2) If any operational functions need to be fixed, it is necessary to implement after pressing the

red “Emergency Shutdown” button.

3) Select and operate the red “Emergency Shutdown” button of the lower control box to shut down the platform.

## 9.5 Auxiliary Power

If the main power fails, the auxiliary power should be used.

- 1) Turn the key switch to the ground or platform for control.
- 2) Pull out the red “Emergency Shutdown” button to the “ON” position.
- 3) When operating the power unit (i.e., emergency pump) on the platform, press the foot switch.
- 4) Enable the desired function while keeping the power unit (i.e., emergency pump) open. The drive function will not work with the power unit.
- 5) Do not use the auxiliary power for a period of more than 30min.

## 9.6 Operation from the Ground Control Station

- 1) Turn the key switch to the lower control box.
- 2) Pull the red “Emergency Stop” button to the “ON” position.
- 3) Push the engine startup switch of the engine to the start position for 2s to 3s, followed by starting up the engine.
- 4) Adjust platform position.
  - Press and hold the function enabling button.
  - Move the proper toggle switch according to the mark on the control panel, and adjust the platform to a suitable position. Driving and steering functions cannot be used from the ground.

## 9.7 Operation from the Platform Control Station

- 1) Turn the key switch to the upper control box position.

2) Pull out the red “Emergency Shutdown” buttons on the ground and the platform to the “ON” position.

3) Push the engine startup switch to the start position for 2s to 3s, followed by starting up the engine. Do not step down on the pedal switch when starting up the engine.

4) Adjust platform position.

- Step down on the pedal switch.
- Slowly activate the function control handle or the toggle switch as per the icon on the control panel.

5) Steering

- Step down on the pedal switch.
- Turn the steering wheels by pushing the thumb rocker on the top of the control handle. Press the button on the left side of the thumb rocker, the steering wheel of the machine will turn left; and press the button on the right side of the thumb rocker, the steering wheels of the machine will turn right.

 **Caution: Determine the steering direction of the wheels using the direction arrows on the upper control box and the machine chassis.**

6) Driving

- Step down on the pedal switch.
- Increase the speed: Slowly move the driving controller handle, making it off center.
- Decrease the speed: Slowly move the driving controller handle, making it point at the center.

Stop: Return the driving control handle to the center position or release the pedal switch.

 **Caution: Determine the direction of driving the machine using color label direction arrows on the upper control box and the driving chassis.**

7) Drive the machine on a slope.

- Determine the uphill, downhill and side

slope ratings of the vehicle.



Maximum slope rating, platform downhill: 30% (17°)



Maximum slope rating, platform uphill (climbing ability): 45% (24°)



Maximum slope rated value: 25% (14°)



**Caution: The slope rating is limited by the ground conditions and traction.**

- Make sure the boom is below horizontal position and the platform is between the non-steering wheels. Select machine on incline drive setting.
- Determine the slope using the following procedure.

Measure the slope with a digital inclinometer or follow the steps below.

- ✓ The following tools are required: Carpenter's ruler, straight block at least 1 m long, and a tape measure.
- ✓ Place the wood block on the slope, place the carpenter's ruler on the upper edge of the wood block at the end of the downhill slope and raise the end of the block until it is level.
- ✓ Keep the block level and measure the vertical distance from the bottom of the block to the ground.
- ✓ d) Divide the tape measure distance (the raised height) by the block length (travel) and multiply by 100.

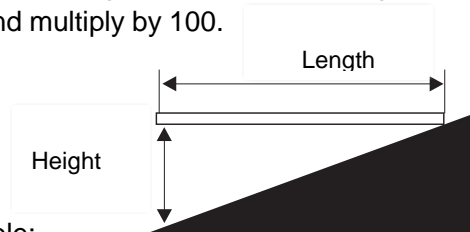

Example:

Wood block = 3.6m

Travel = 3.6m

Raised height = 0.3m

$0.3/3.6=8.3\%$  rating

If the slope exceeds the maximum uphill, downhill or side slope rating, the vehicle must be lifted or transported up and down the slope. See the Transportation and Lifting section for further instructions on transporting the machine.

### 8) Drive enabling

- If the indicator is on, it indicates that the boom has moved beyond one of the two non-steering wheels and the drive function is disabled.
- To drive, turn the driving enabling switch to either side, while slowly moving the driving control handle away from the center position.

Note: The vehicle may move in the opposite direction to the drive and steering control handles.

- Always determine the direction in which the vehicle drives according to the directional arrow on the upper control box.

### 9) Selection of drive speed

- The machine is located at sign on the slope: The engine is switched to high idle speed automatically. To acquire more driving torque, select the slope sign on the inclined or rough ground.
- The machine is located at the sign on the horizontal plane: For operation of maximum driving speed.

### 10) Selection of engine idle speed

- Select engine idle speed with the sign on the control panel.
- In the case of failure to stepdown of pedal switch or toggling of handle, the engine will keep idle speed at the lowest revolution.

Turtle sign: Step down on the pedal switch to activate low idle speed.

Rabbit sign: Step down on the pedal switch to activate high idle speed.

When the vehicle goes downhill, please operate within the low speed range.

## 9.8 Platform overload

The platform overload indicating lamp is ON, and the alarm gives an alarm, indicating the slight overload of platform. Unload the platform until the lamp is OFF before continuing to operate.

## 9.9 Tilt Indicator

If the lamp is on, it indicates the vehicle is not level. When the indicator is on, the alarm will sound and the vehicle must be moved to a hard, level surface. Determine the state of the articulating boom on slope, as shown below. Before moving the machine to the solid and horizontal ground, lower the articulating boom per the following steps. Before lowering the boom, do not rotate the boom.

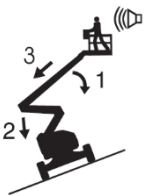

If the tilt alarm sounds on the up-slope of platform:

1. Lower the first boom.
2. Lower the second boom.
3. Retract the first boom.

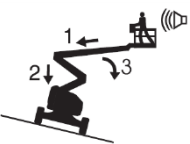

If the tilt alarm sounds on the down-slope of platform:

1. Retract the first boom.
2. Lower the second boom.
3. Lower the first boom.

## 9.10 System Fault

The alarm sounds, and the system fault indicating lamp is ON, indicating that the control system has a fault. The LED display will show the corresponding fault code, and the

corresponding functions of the machine will be shut down, shown as Table 9-1.

When the system indicating lamp is ON, operate as per the following steps:

- 1) Lower and retract boom.
- 2) Move the machine to the stowed position, shut down the engine, tag out the machine and shut down.
- 3) The machine can be used again only after relevant qualified personnel maintain, troubleshoot and conduct complete inspection.
- 4) System fault code is shown as the following figure:

| Fault Code | Fault Description   | Limit Action                             | Fault Code | Fault Description                                  | Limit Action                             |
|------------|---|--|------------|--|--|
| 1          | Cutoff of controller output power supply 1                              | Limit all actions                        | 12         | Fault of right handle                              | Amplitude of variation on principal arm  |
| 2          | Cutoff of controller output power supply 2                              | Limit all actions                        | 13         | Fault of middle handle                             | Amplitude of variation on principal boom |
| 3          | Cutoff of controller output power supply 3 and 4                        | Limit all actions                        | 14         | Boom luffing limit switch fault                    | Limit all actions                        |
| 4          | Disconnection of CAN bus of extended module of electric box of platform | Limit all actions                        | 15         | Folding boom luffing limit switch fault            | Limit all actions                        |
| 5          | Chassis electric box display Bus break circuit                          |  | 16         | Boom telescoping limit switch fault                | Limit all actions                        |
| 6          | Weighing fault  |  | 17         | Rear area detection limit switch fault             | Limit all actions                        |
| 7          | Weighing sensor 1 fault   |  | 101        | Chassis inclination                                |  |
| 8          | Weighing sensor 2 fault   |  | 102        | Walking motion is limited due to unactivated drive |  |
| 9          | Weighing sensor checkout fault  |  | 103        | Working bucket overweighted                        |  |
| 10         | Weighing sensor 4 fault   |  | 104        | Low Fuel level warning                             |  |
| 11         | Fault of left handle  | Amplitude of variation on principal boom | 105        | Oil pressure warning                               |  |
|            |   |  | 106        | Oil temperature warning                            |  |

Table 9-1 System fault codes and limit actions

## 9.11 Parking and Storage

- 1) Select a solid, level, and safe position where it is moisture-proof, high-temperature resistant, open flame resistant, free from corrosive gas and well-ventilated.
- 2) Retract and lower the boom to the stowed state.
- 3) Close and lock all enclosures and box doors.
- 4) Wipe up dust and oil dirt on the machine body, and keep the machine clean.
- 5) Rotate the turntable to make the boom located between non-steering wheels.
- 6) Turn the key toggle switch to the "OFF" position, and remove the key to avoid unauthorized use.
- 7) During long-term storage:
  - Disconnect the positive and negative electrodes of the battery, drain the fuel completely, and prior to use, conduct overall cleaning and maintenance on the entire machine.
  - When the storage period exceeds three months, run the machine for not less than one hour every three months, and conduct cleaning and maintenance.
  - Secure the wheels using wheel chocks.

## 9.12 Instructions for skyguard

- 1) The Skyguard protective system aims to create safe and convenient operating environment for operators on the basis of ensuring operation convenience, the loading capacity of the platform and the operators' field of view.
- 2) The Skyguard protective device is disposed above the control panel of the platform. If the safety pole is stressed, the protective system will be activated instantly, and the device will stop all actions immediately, thereby preventing operators from suffering

from secondary injury.

- 3) In the extreme case, the safety pole in the protective device will slip to the bottom to ensure operators have sufficient space for buffering and operation. Upon the activation of the Skyguard protective system, the device will give an alarm prompt tone immediately while the blue alarm light flickers. Through the above two approaches, other site operators are reminded, and the safety awareness of neighboring personnel is improved. In addition, the Skyguard protective system also provides the safety overriding switch for operators, facilitating operators to remove dangers. Benefiting from rigid components of the Skyguard protective system, the reliability of the system is improved greatly, and regular or additional maintenance is reduced.

## 9.13 Fall protection

- 1) Personal fall protection equipped (PFPE) is required when operating the machine.
- 2) All PFPE must comply with applicable governmental regulations, and must be inspected and used in accordance with the PFPE manufacturer's instructions.

## 9.14 Machine Safety System

### Override(MSSO)(If equipped)

Machine Safety System Override function (use auxiliary power or press the platform anti-collision bypass button) can only be used when the safety limit is activated so that the operator can maintain its work in such a situation.

Note: once the MSSO is activated, a yellow icon will be displayed on the screen as shown in the picture listed below. To remove the icon, you need to turn to LGMG service personnel for help.



## **Chapter 10 Instructions for Transportation and Lifting**





## 10.1 Compliance

- 1) Only personnel with high-altitude lifting qualifications can load and unload the vehicle.
- 2) The transport vehicle must be parked on a level surface.
- 3) When loading the vehicle, the transport vehicle must be secured to prevent movement.
- 4) Make sure the transport vehicle's capacity, loading surface, chains or belts are sufficient to withstand the weight of the vehicle. Refer to the nameplate for the weight of the vehicle.
- 5) Make sure the turntable has been secured with the rotation lock before transporting. Make sure to unlock the turntable before operation.
- 6) Do not drive the vehicle on a slope that exceeds the vehicle's uphill, downhill or slope rating. Refer to "Drive on the Slope" in the "Operation Instructions" section.
- 7) If the slope of the transport vehicle exceeds the maximum slope rating, the winch must be used to load and unload the vehicle as specified.
- 8) The vehicle is equipped with a sophisticated weighting system. It is forbidden to place heavy goods on the platform, when the vehicle is transporting, otherwise the weighting system may be damaged.

## 10.2 Freewheel configuration for trailers

- 1) Wedge the wheel to prevent the vehicle from moving.
- 2) Flip over the drive hub cover to release the non-steering wheel brake.
- 3) Make sure that the winch cable is properly secured to the fastening point of the drive chassis and that there are no obstacles in the moving direction.

After the vehicle is loaded:

- ① Wedge the wheel to prevent the vehicle from moving.
- ② Flip over the drive hub cover to engage the non-steering wheel brake.

**⚠ Caution: Do not tow the vehicle. If the vehicle must be towed, the speed may not exceed 3.2km/h.**

## 10.3 Transportation Safety

- 1) The vehicle wheels must always be locked when preparing for transport.
- 2) Before transporting, turn the key switch to the "OFF" position and remove the key.
- 3) Thoroughly inspect the vehicle to prevent loose or unsecured parts.
- 4) Secure the vehicle to the transport surface with the fastening points on the chassis.
- 5) Use at least four chains or belts.
- 6) Make sure the chain or belt used has sufficient load strength.
- 7) Adjust the sling to prevent damage to the chain.

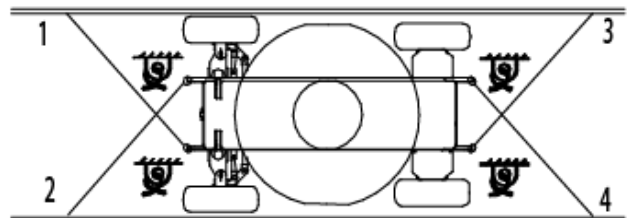

- 8) Make sure that the Jib and platform are telescoped. Protect the platform with the nylon strap on the platform base near the platform rotator (as shown below). Do not apply excessive downward force when protecting the boom components.

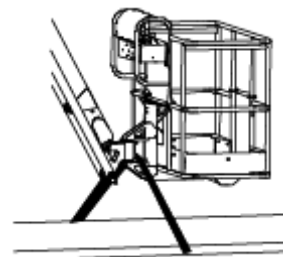

## 10.4 Lifting instructions

Keep in mind the following:

- 1) Only qualified rigging personnel can assemble the sling and lift the vehicle.
- 2) Make sure that the crane's lifting capacity, loading surface, belt or rope is sufficient to withstand the weight of the vehicle. Refer to the label and nameplate for the weight of the vehicle.

### Lifting instructions

- 1) Lower and retract the boom completely. Lower the Jib completely. Remove any loose parts from the vehicle.
- 2) Determine the center of gravity of the vehicle with the help of the picture below.
- 3) Only connect the lifting sling to the specified lifting point on the vehicle. There are four lifting points on the chassis.
- 4) Adjust the sling to avoid any damage to the vehicle and keep the vehicle in a level position.

| Model | X      | Y      |
|-------|--------|--------|
| AR16J | 1150mm | 1170mm |

